

## PWM 160180180 SKF

Plain bushes

TYPE: Plain bearings, Bushings, thrust washers and strips, Bushings, Without flange, Filament wound (SKF)

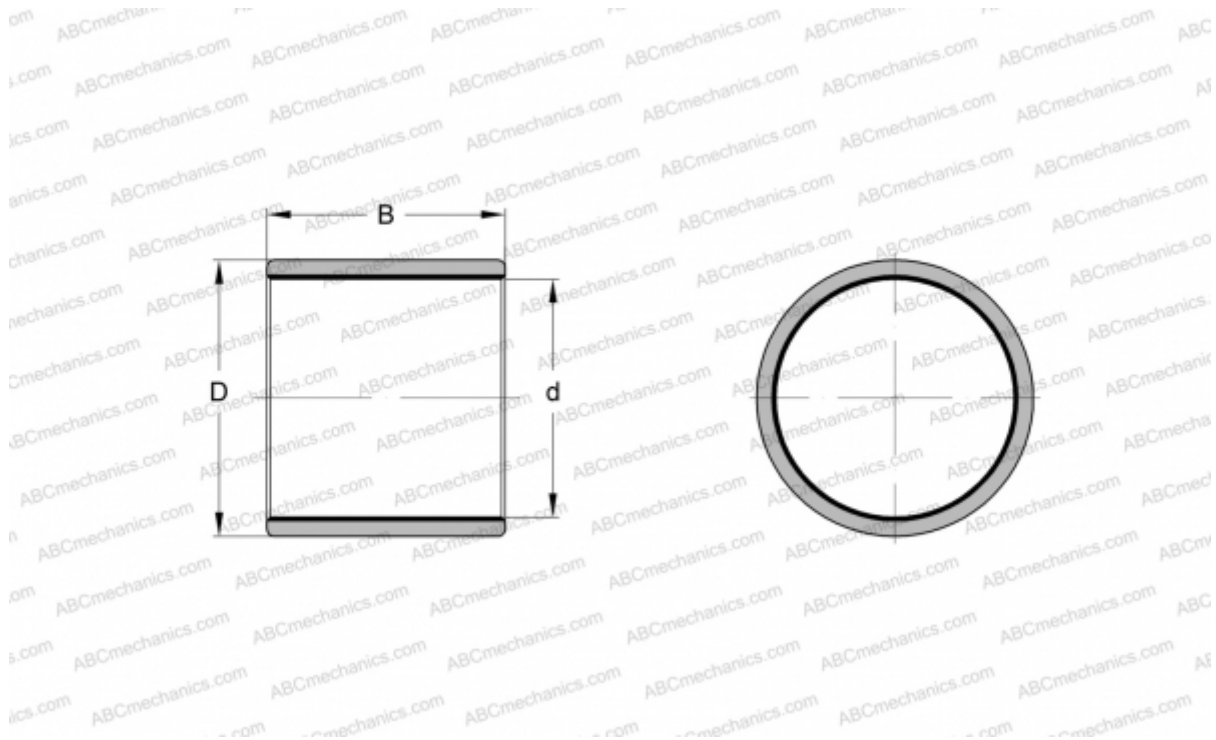

### Technical specification

#### DIMENSIONS, MM

d	160,000
D	180,000
B	180,000

#### MANUFACTURER

[SKF](#)