

## PWM 170190120 SKF

Plain bushes

TYPE: Plain bearings, Bushings, thrust washers and strips, Bushings, Without flange, Filament wound (SKF)

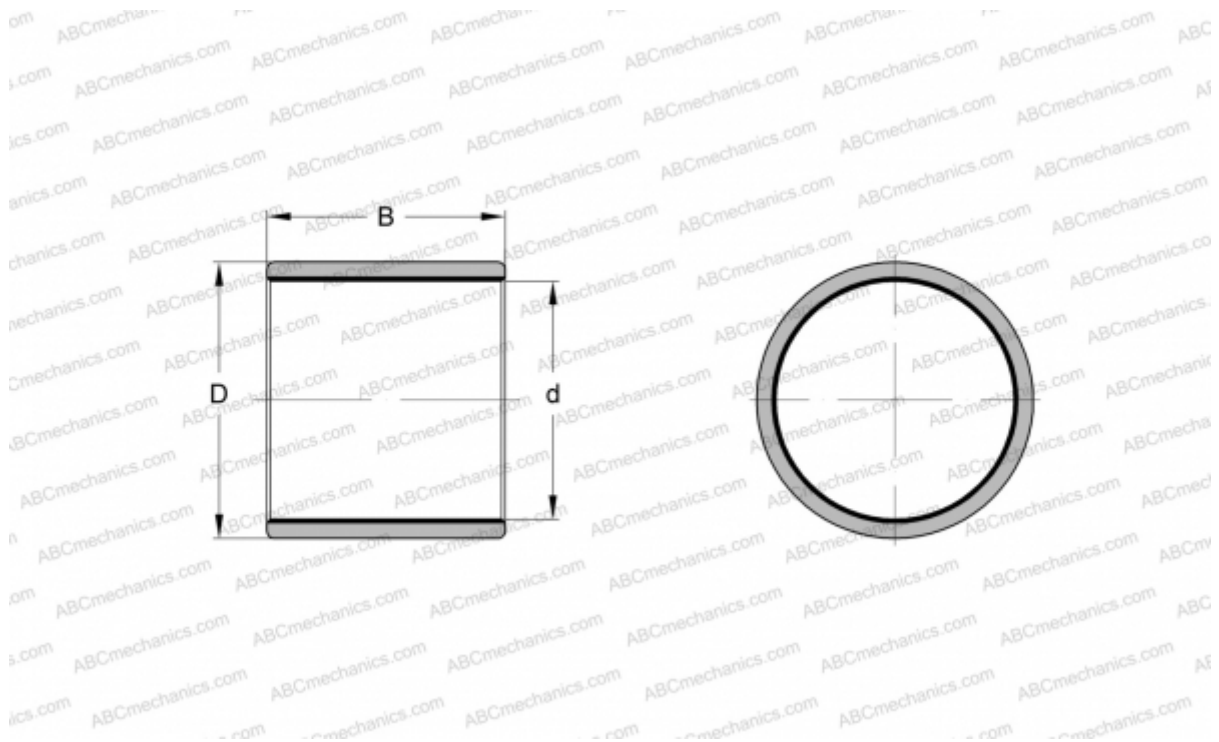

### Technical specification

#### DIMENSIONS, MM

d	170,000
D	190,000
B	120,000

#### MANUFACTURER

[SKF](#)