

PWM 170190180 SKF

Plain bushes

TYPE: Plain bearings, Bushings, thrust washers and strips, Bushings, Without flange, Filament wound (SKF)

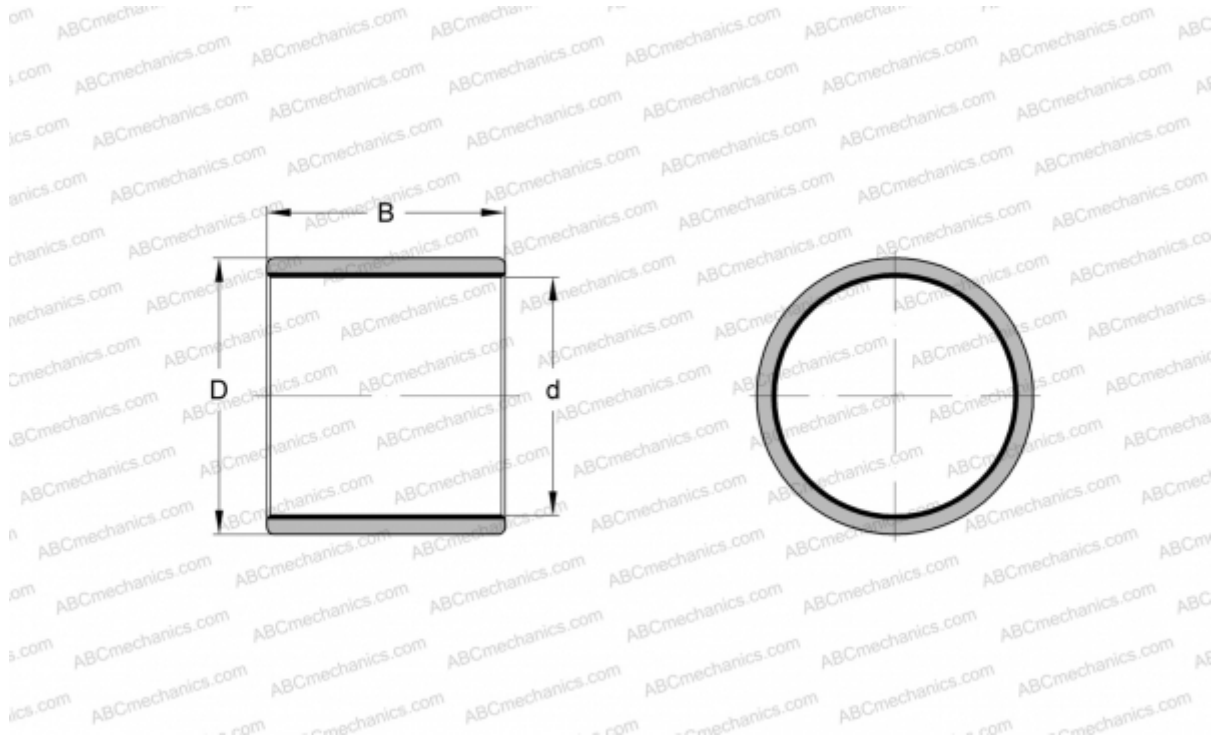

Technical specification

DIMENSIONS, MM

d	170,000
D	190,000
B	180,000

MANUFACTURER

[SKF](#)