

PWM 180200180 SKF

Plain bushes

TYPE: Plain bearings, Bushings, thrust washers and strips, Bushings, Without flange, Filament wound (SKF)

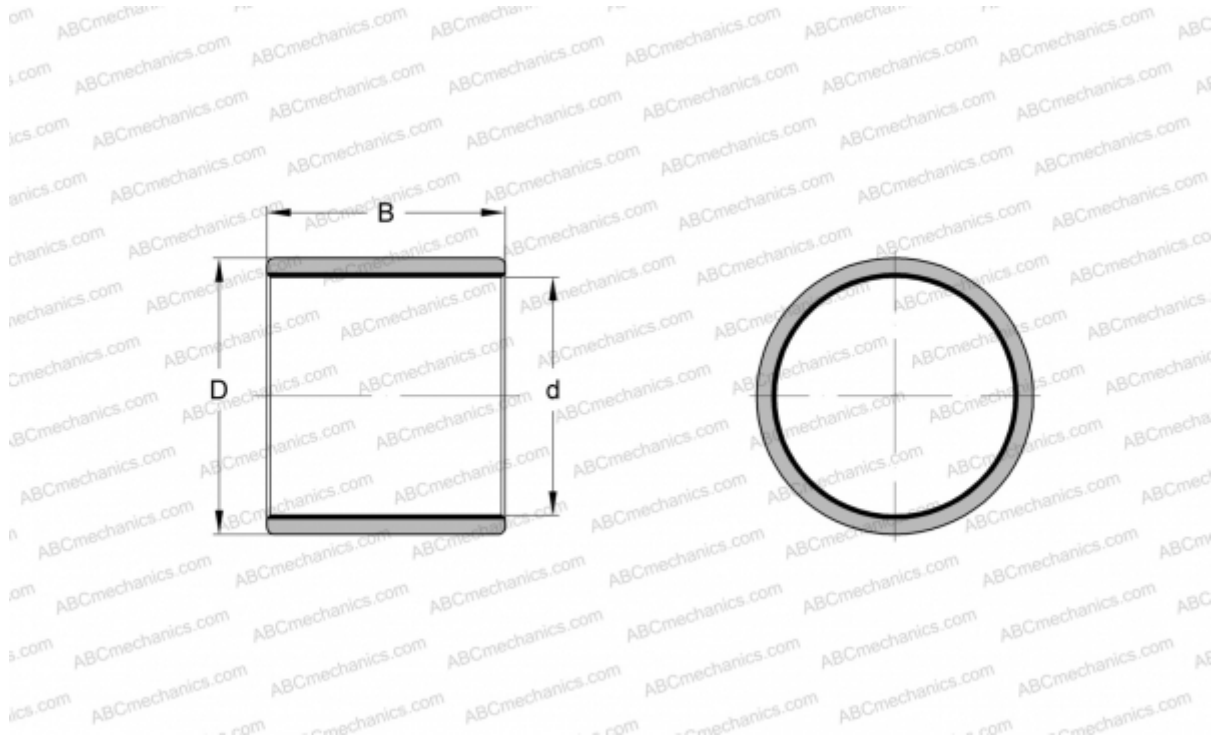

Technical specification

DIMENSIONS, MM

d	180,000
D	200,000
B	180,000

MANUFACTURER

[SKF](#)