

## PWM 200220180 SKF

Plain bushes

TYPE: Plain bearings, Bushings, thrust washers and strips, Bushings, Without flange, Filament wound (SKF)

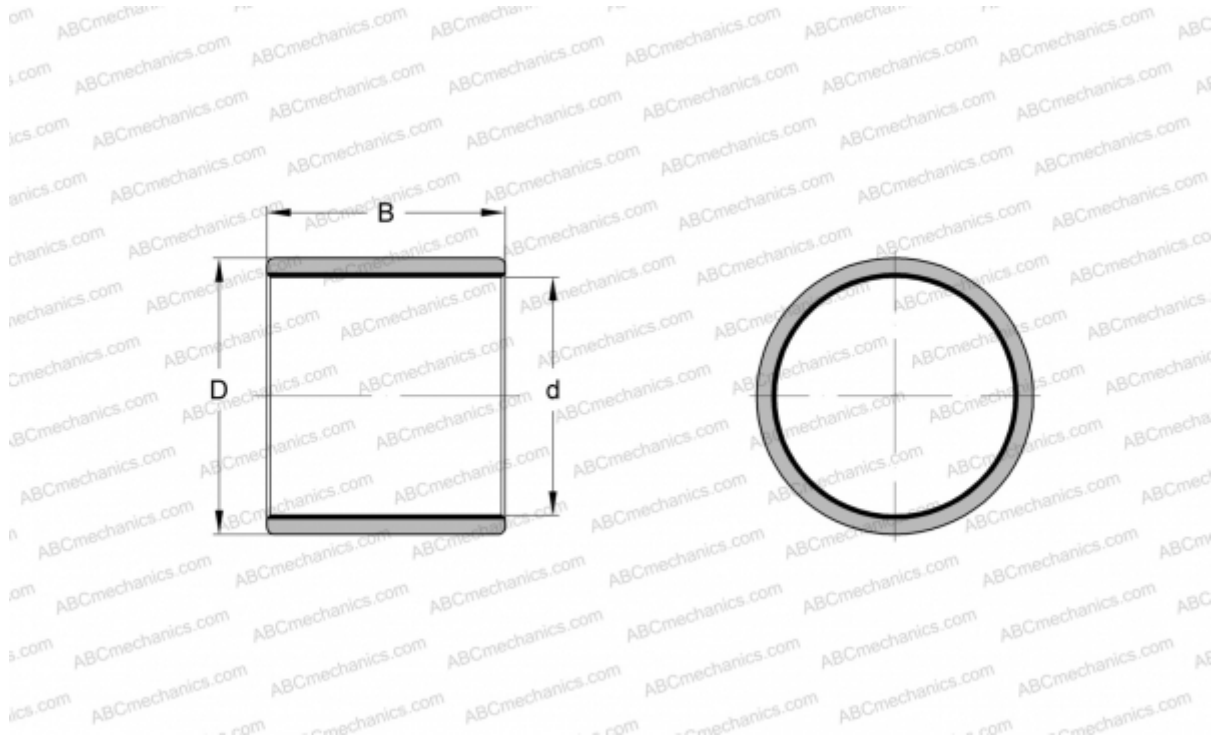

### Technical specification

#### DIMENSIONS, MM

d	200,000
D	220,000
B	180,000

#### MANUFACTURER

[SKF](#)