

EGF06070-E40 INA

Plain bushes

TYPE: Plain bearings, Bushings, thrust washers and strips, Bushings, Flanged, Maintenance-free, with steel backing (INA)

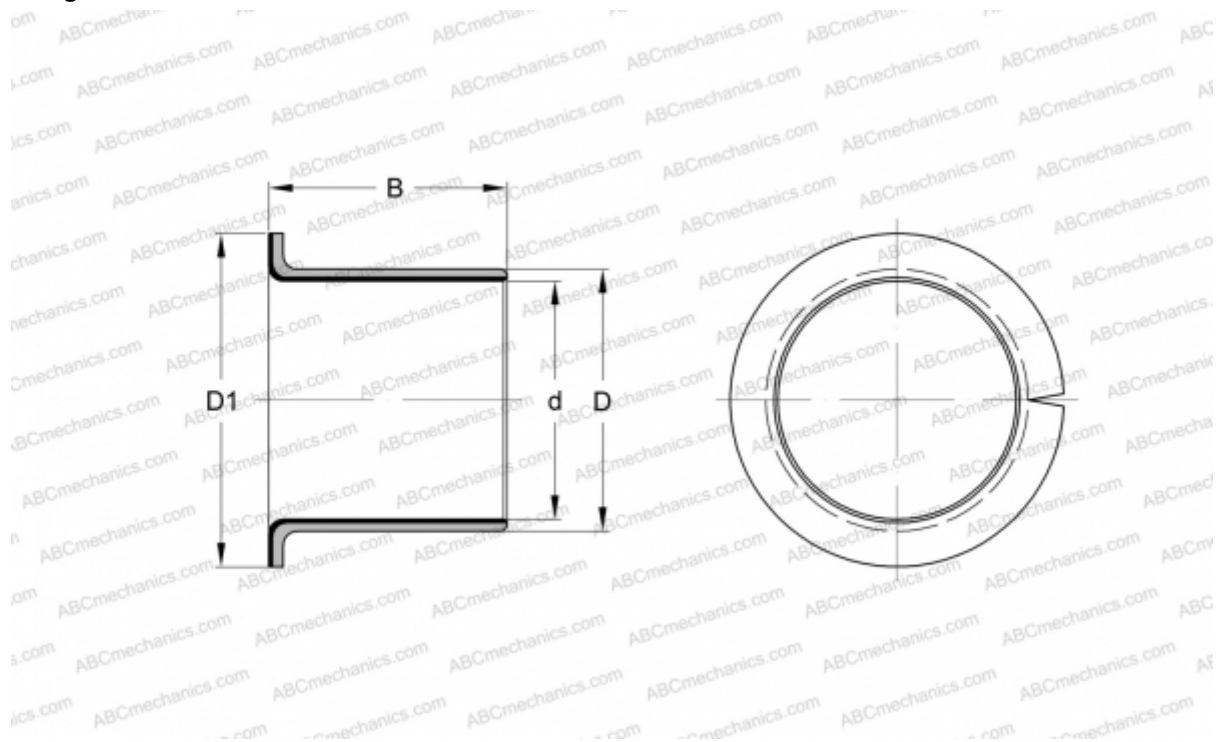

Technical specification

DIMENSIONS, MM

d	6,000
D	8,000
D1	12,000
B	7,000

WEIGHT, KG 0,001

MANUFACTURER [INA](#)

REPLACES

PAF06070-P14