

EGF08095-E40 INA

Plain bushes

TYPE: Plain bearings, Bushings, thrust washers and strips, Bushings, Flanged, Maintenance-free, with steel backing (INA)

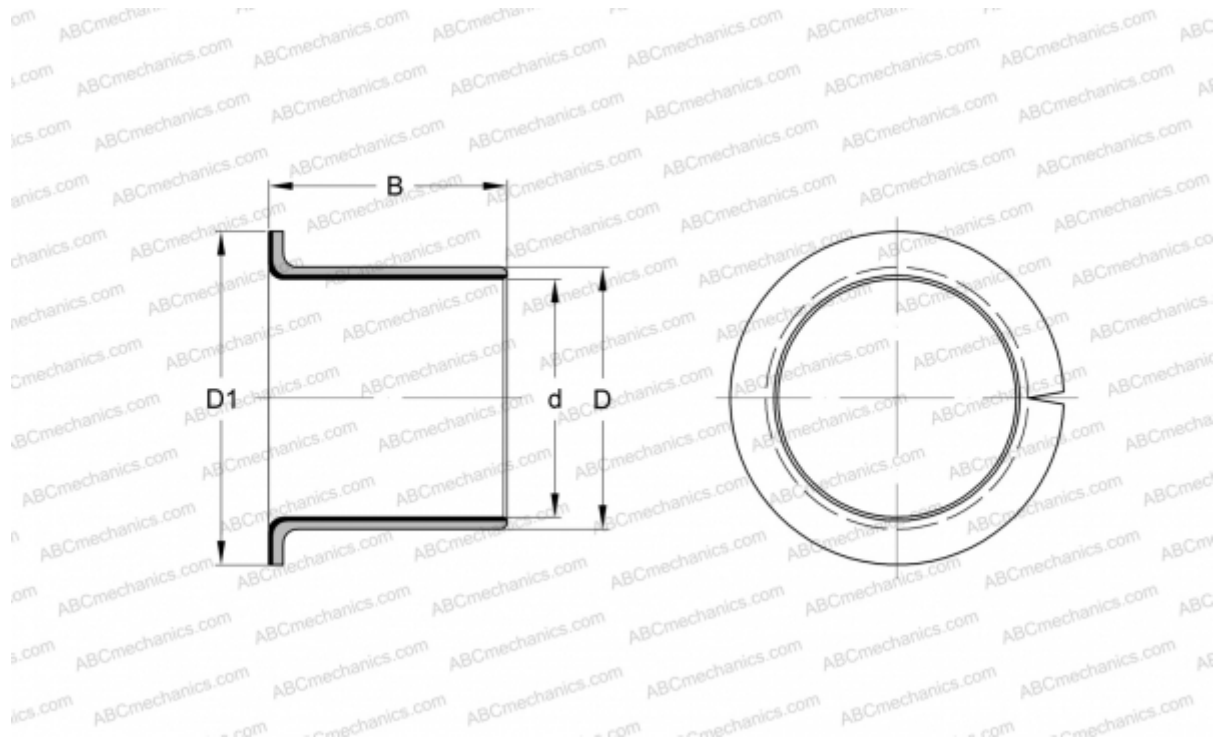

Technical specification

DIMENSIONS, MM

d	8,000
D	10,000
D1	15,000
B	9,500

WEIGHT, KG 0,002

MANUFACTURER [INA](#)

REPLACES

PAF08095-P14