

EGF16120-E40 INA

Plain bushes

TYPE: Plain bearings, Bushings, thrust washers and strips, Bushings, Flanged, Maintenance-free, with steel backing (INA)

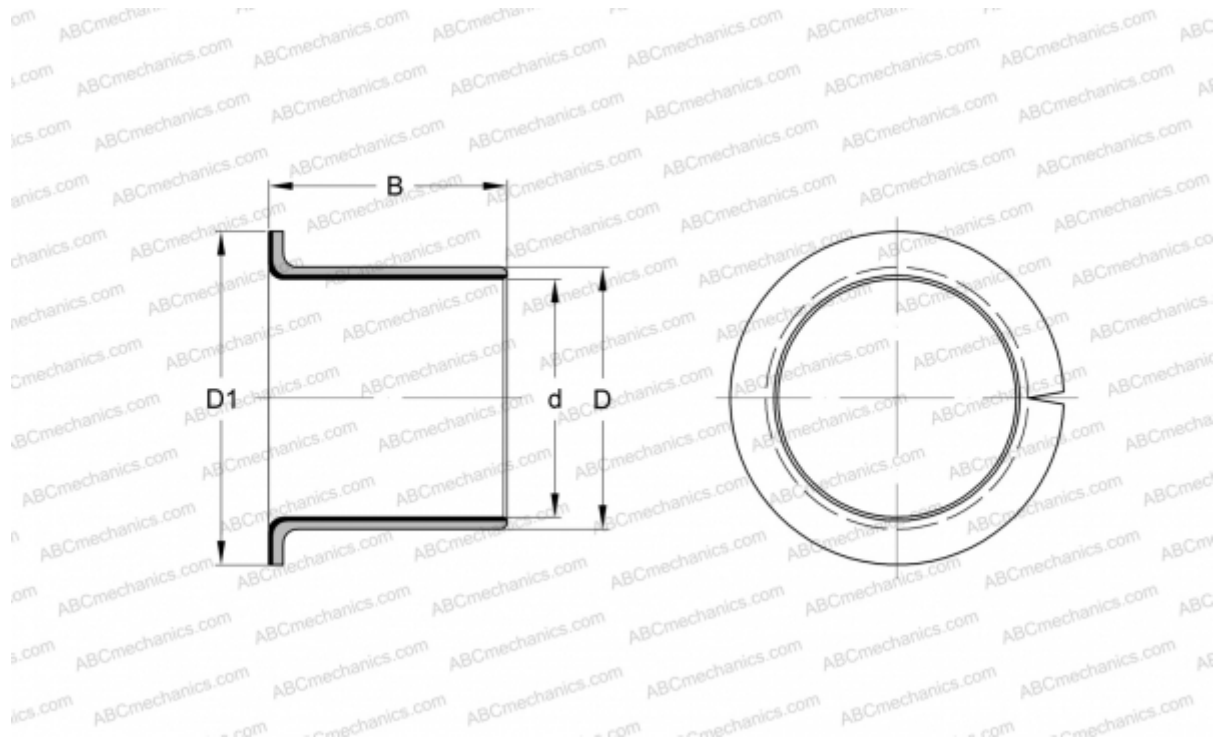

Technical specification

DIMENSIONS, MM

d	16,000
D	18,000
D1	24,000
B	12,000

WEIGHT, KG 0,006

MANUFACTURER [INA](#)

REPLACES

PAF16120-P14