

EGF30160-E40 INA

Plain bushes

TYPE: Plain bearings, Bushings, thrust washers and strips, Bushings, Flanged, Maintenance-free, with steel backing (INA)

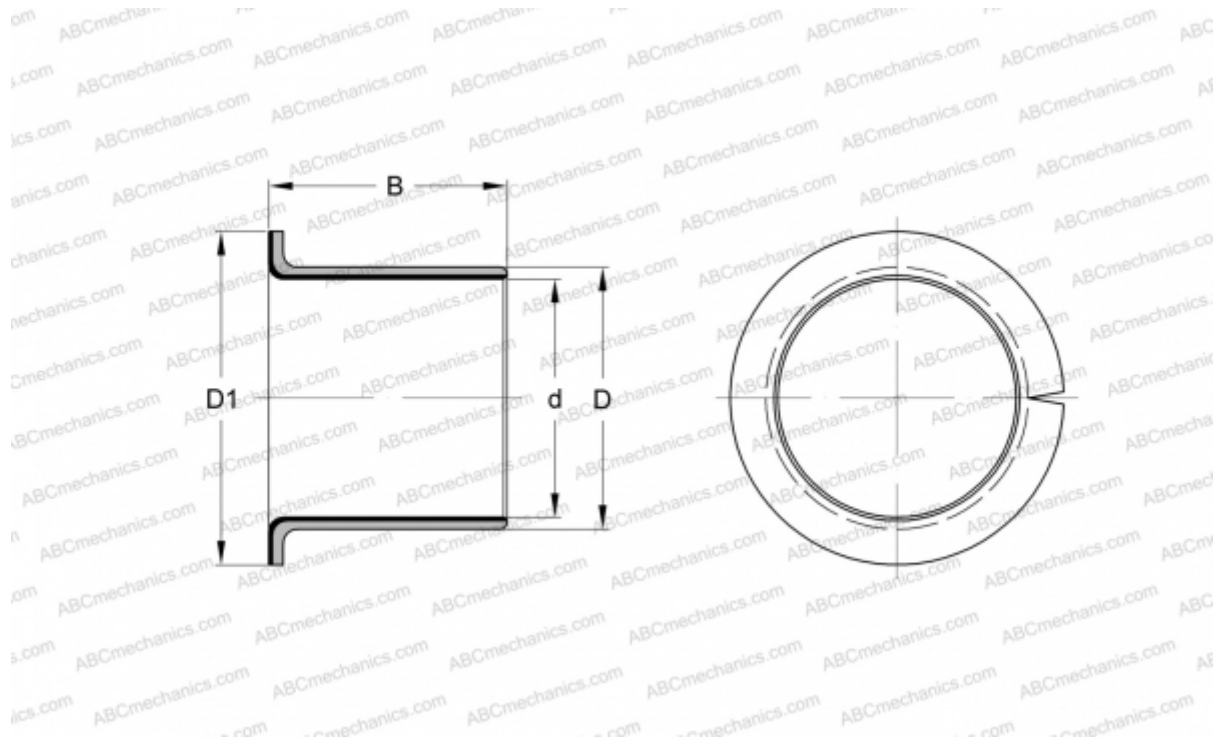

Technical specification

DIMENSIONS, MM

d	30,000
D	34,000
D1	42,000
B	16,000

WEIGHT, KG 0,029

MANUFACTURER [INA](#)

REPLACES

PAF30160-P14