

EGF40260-E40 INA

Plain bushes

TYPE: Plain bearings, Bushings, thrust washers and strips, Bushings, Flanged, Maintenance-free, with steel backing (INA)

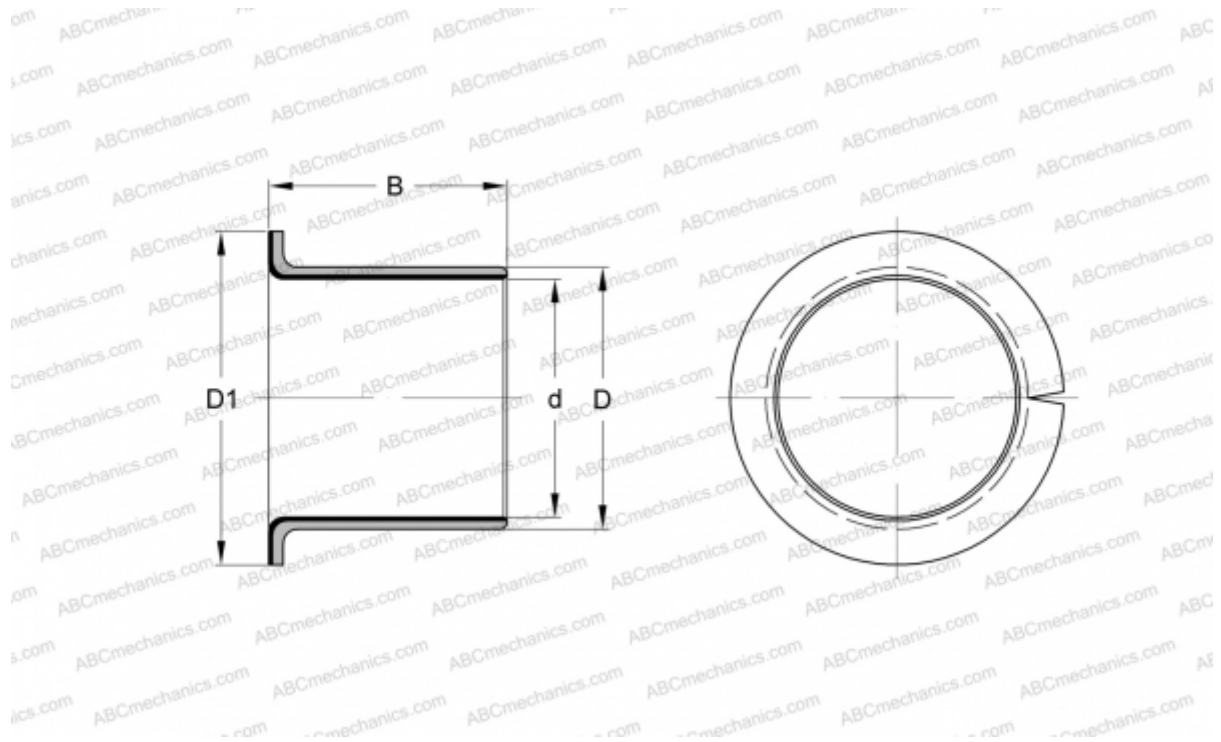

Technical specification

DIMENSIONS, MM

d	40,000
D	44,000
D1	53,000
B	26,000

WEIGHT, KG 0,059

MANUFACTURER [INA](#)

REPLACES

PAF40260-P14