

EGF10070-E40-B INA

Plain bushes

TYPE: Plain bearings, Bushings, thrust washers and strips, Bushings, Flanged, Maintenance-free, with bronze backing (INA)

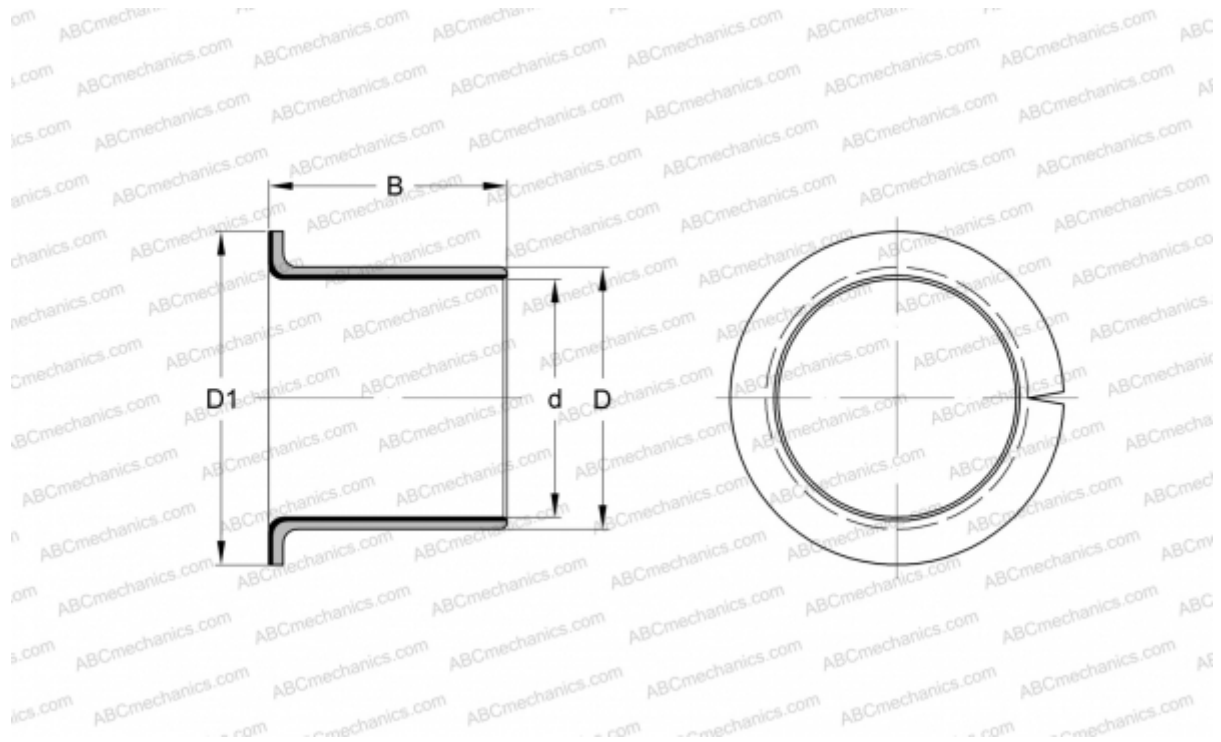

Technical specification

DIMENSIONS, MM

d	10,000
D	12,000
D1	18,000
B	7,000

WEIGHT, KG 0,003

MANUFACTURER [INA](#)

REPLACES

PAF10070-P11