

PCMF 182012 E SKF

Plain bushes

TYPE: Plain bearings, Bushings, thrust washers and strips, Bushings, Flanged, Maintenance-free, PTFE composite (SKF)

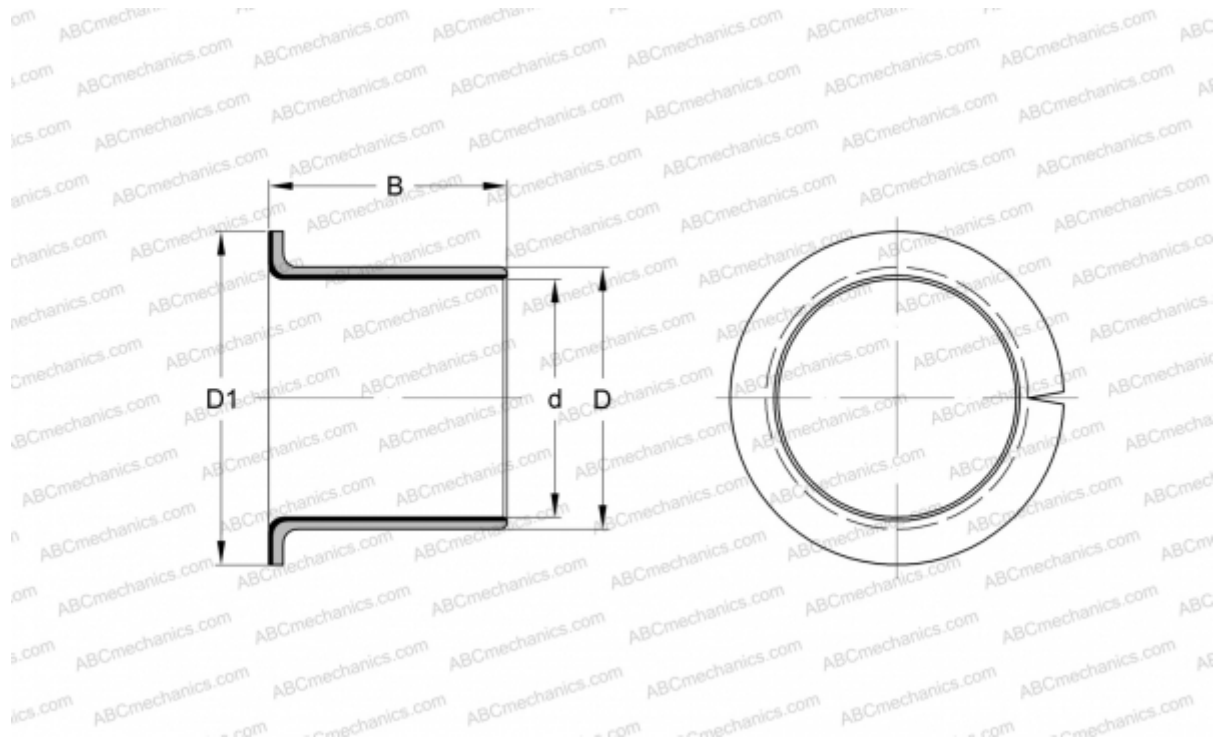

Technical specification

DIMENSIONS, MM

d	18,000
D	20,000
D1	26,000
B	12,000

WEIGHT, KG 0,007

MANUFACTURER [SKF](#)

REPLACES

PCMF182012B