

PCMF 202321.5 E SKF

Plain bushes

TYPE: Plain bearings, Bushings, thrust washers and strips, Bushings, Flanged, Maintenance-free, PTFE composite (SKF)

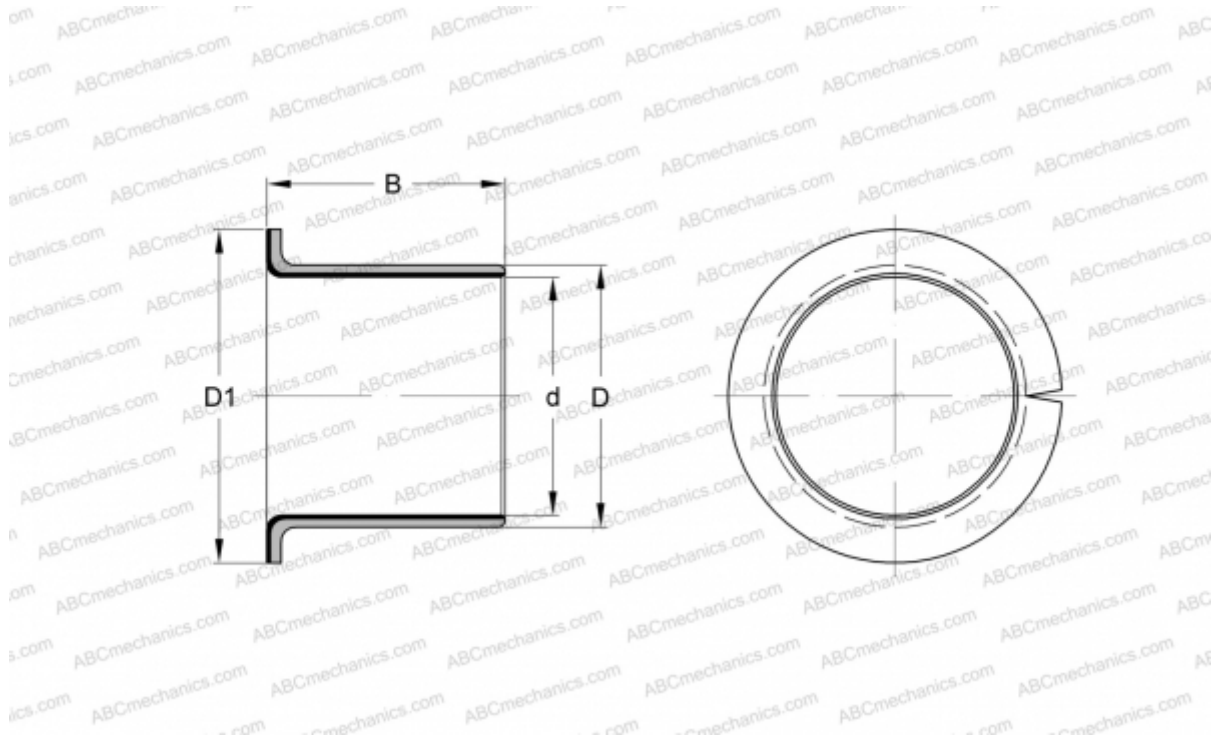

Technical specification

DIMENSIONS, MM

d	20,000
D	23,000
D1	30,000
B	21,500

WEIGHT, KG 0,021

MANUFACTURER [SKF](#)

REPLACES

PCMF202321.5B