

EGW18-E40 INA

Thrust washers

TYPE: Plain bearings, Bushings, thrust washers and strips, Thrust washers, Maintenance-free, with steel backing (INA)

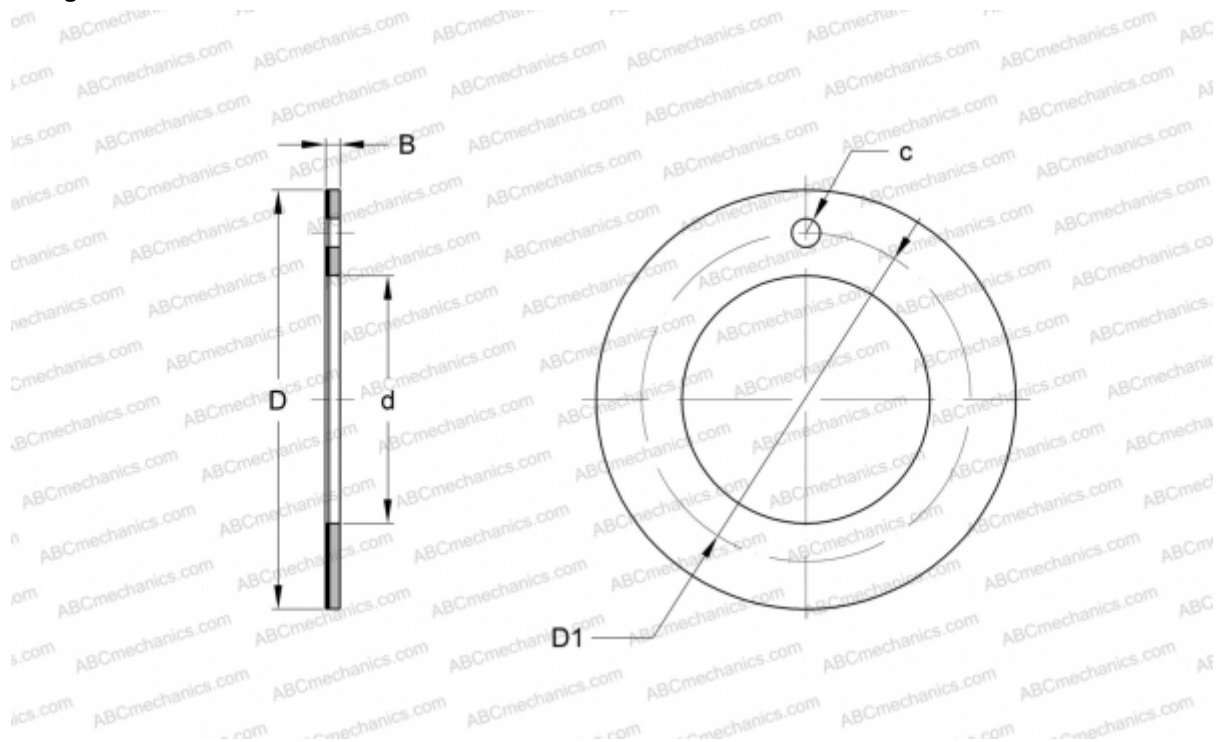

Technical specification

DIMENSIONS, MM

d	18,000
D	32,000
D1	25,000
B	1,500
c	2,000

WEIGHT, KG 0,006

MANUFACTURER [INA](#)

REPLACES

PAW18-P14