

## EGW20-E40 INA

Thrust washers

TYPE: Plain bearings, Bushings, thrust washers and strips, Thrust washers, Maintenance-free, with steel backing (INA)

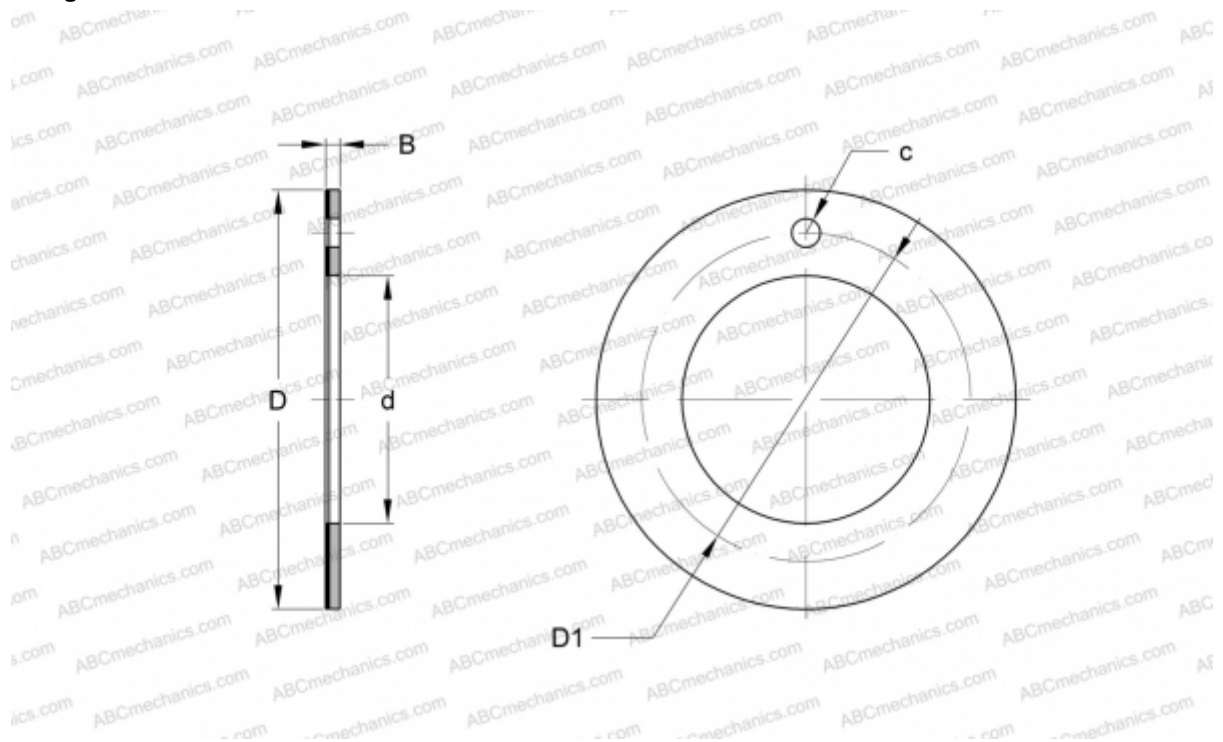

### Technical specification

#### DIMENSIONS, MM

d	20,000
D	36,000
D1	28,000
B	1,500
c	3,000

**WEIGHT, KG** 0,008

**MANUFACTURER** [INA](#)

#### REPLACES

PAW20-P14