

EGW32-E40 INA

Thrust washers

TYPE: Plain bearings, Bushings, thrust washers and strips, Thrust washers, Maintenance-free, with steel backing (INA)

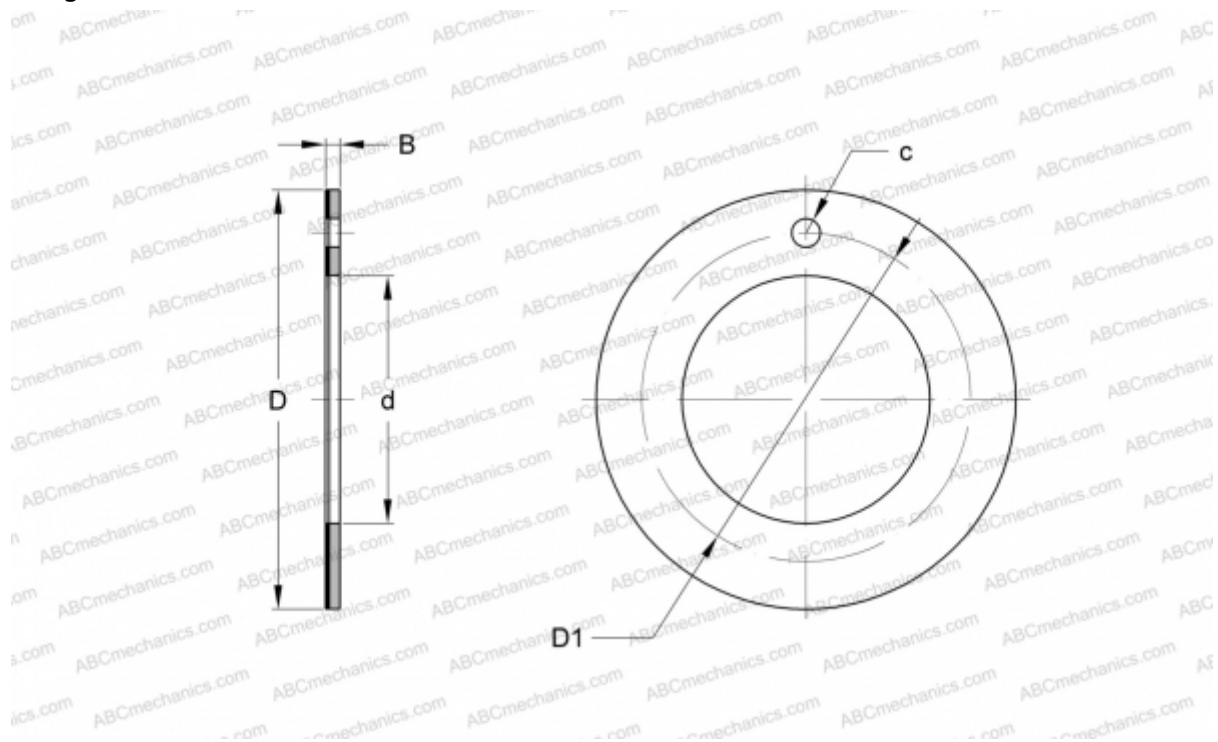

Technical specification

DIMENSIONS, MM

d	32,000
D	54,000
D1	43,000
B	1,500
c	4,000

WEIGHT, KG 0,016

MANUFACTURER [INA](#)

REPLACES

PAW32-P14