

EGW22-E40-B INA

Thrust washers

TYPE: Plain bearings, Bushings, thrust washers and strips, Thrust washers, Maintenance-free, with bronze backing (INA)

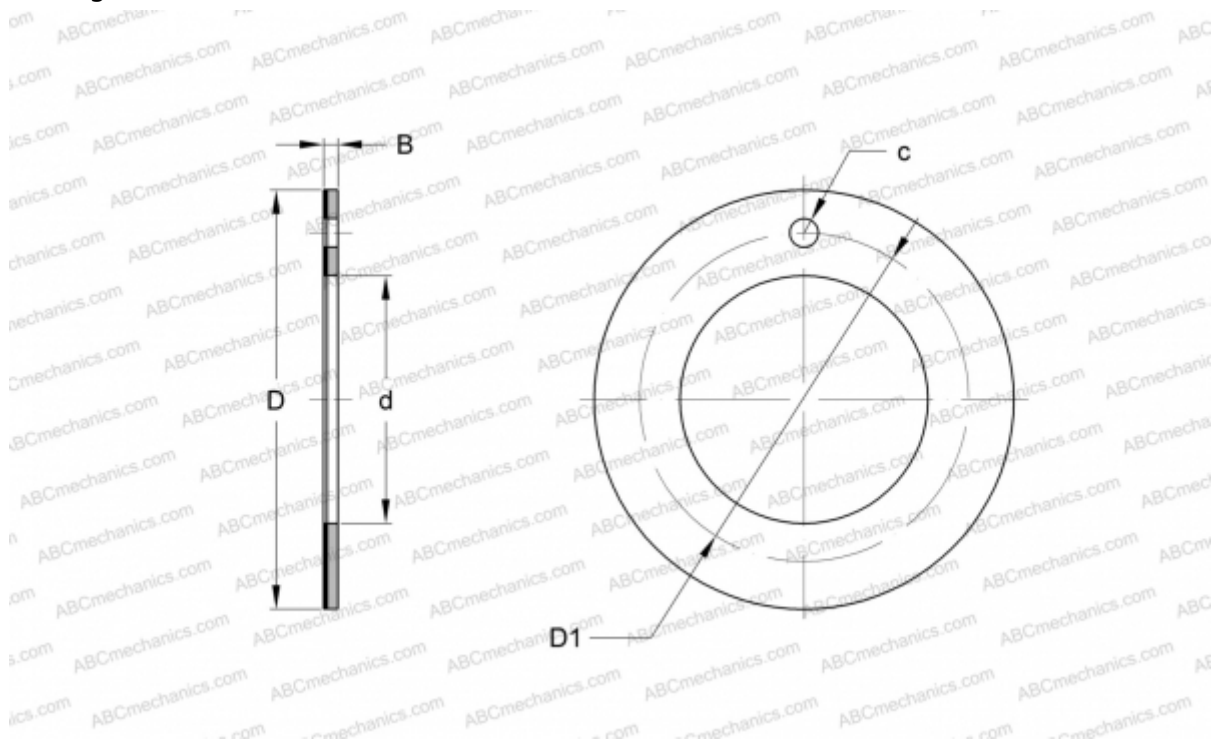

Technical specification

DIMENSIONS, MM

d	22,000
D	38,000
D1	30,000
B	1,500
c	3,000

WEIGHT, KG 0,009

MANUFACTURER [INA](#)

REPLACES

PAW22-P11