

## EGW28-E40-B INA

Thrust washers

TYPE: Plain bearings, Bushings, thrust washers and strips, Thrust washers, Maintenance-free, with bronze backing (INA)

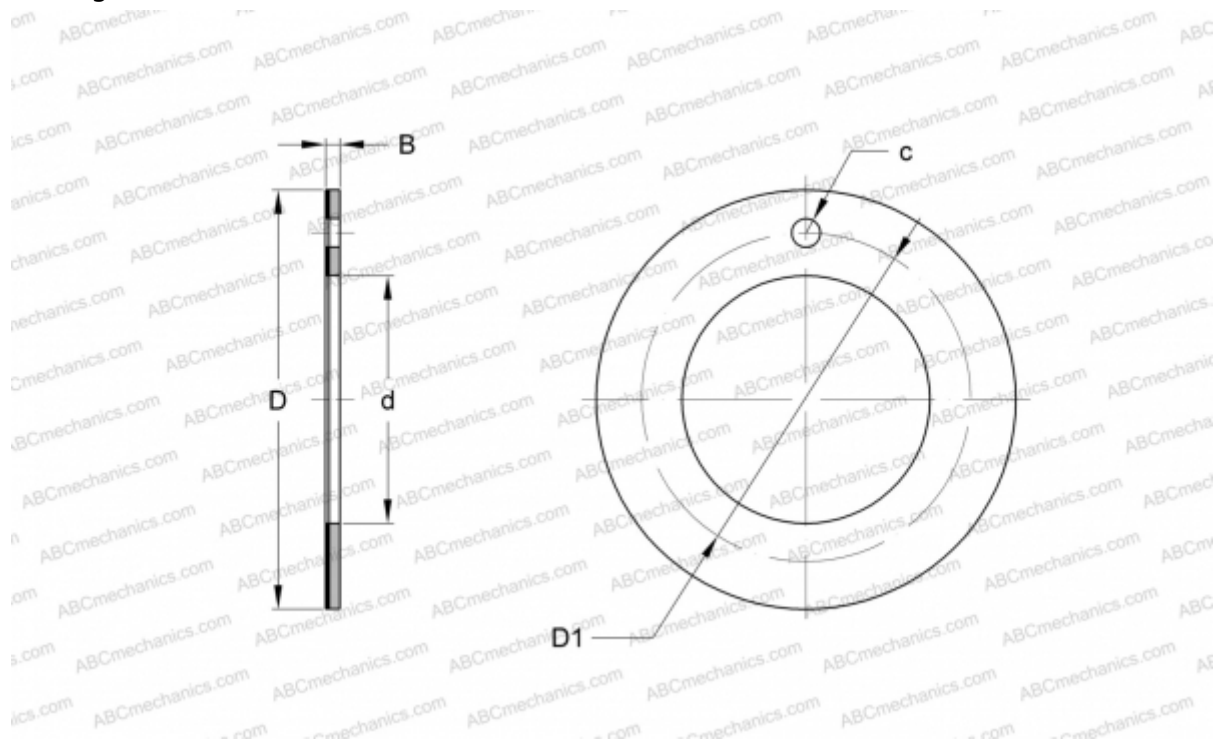

### Technical specification

#### DIMENSIONS, MM

d	28,000
D	48,000
D1	38,000
B	1,500
c	4,000

**WEIGHT, KG** 0,014

**MANUFACTURER** [INA](#)

#### REPLACES

PAW28-P11