

EGW48-E40-B INA

Thrust washers

TYPE: Plain bearings, Bushings, thrust washers and strips, Thrust washers, Maintenance-free, with bronze backing (INA)

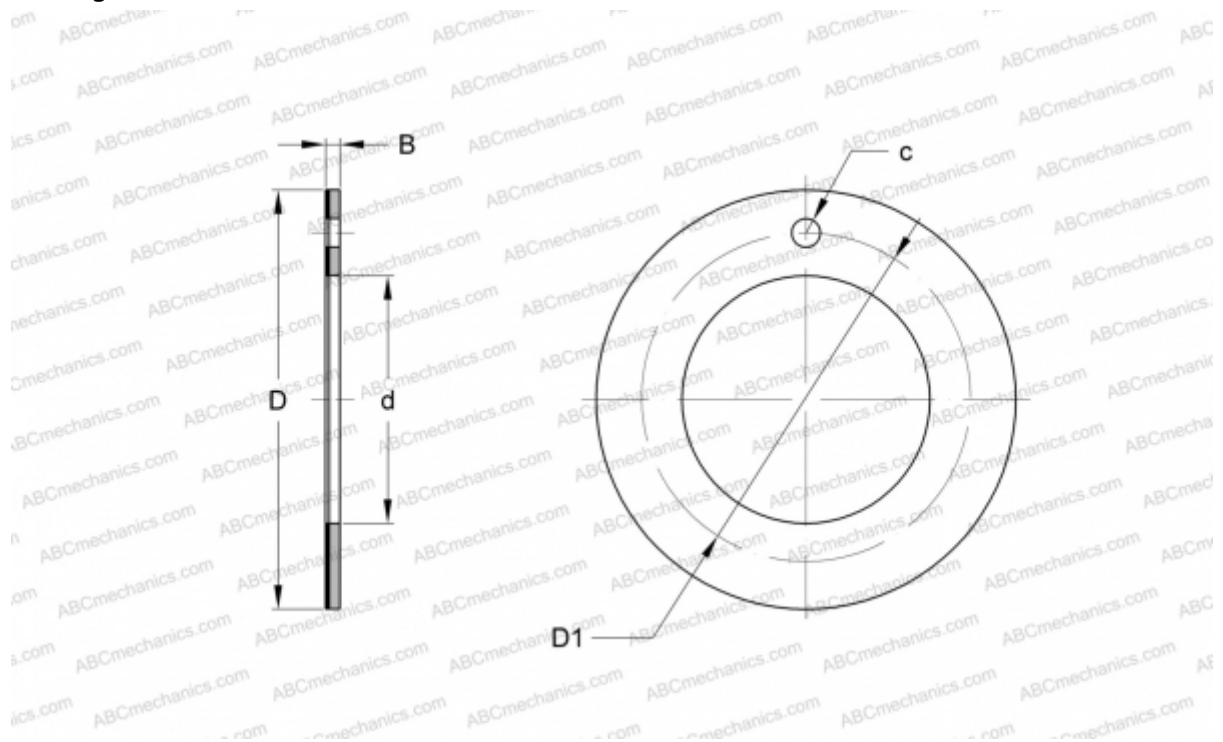

Technical specification

DIMENSIONS, MM

d	48,000
D	74,000
D1	61,000
B	2,000
c	4,000

WEIGHT, KG 0,041

MANUFACTURER [INA](#)

REPLACES

PAW48-P11