

EGW14-E50 INA

Thrust washers

TYPE: Plain bearings, Bushings, thrust washers and strips, Thrust washers, Low-maintenance, with steel backing and lubrication pockets (INA)

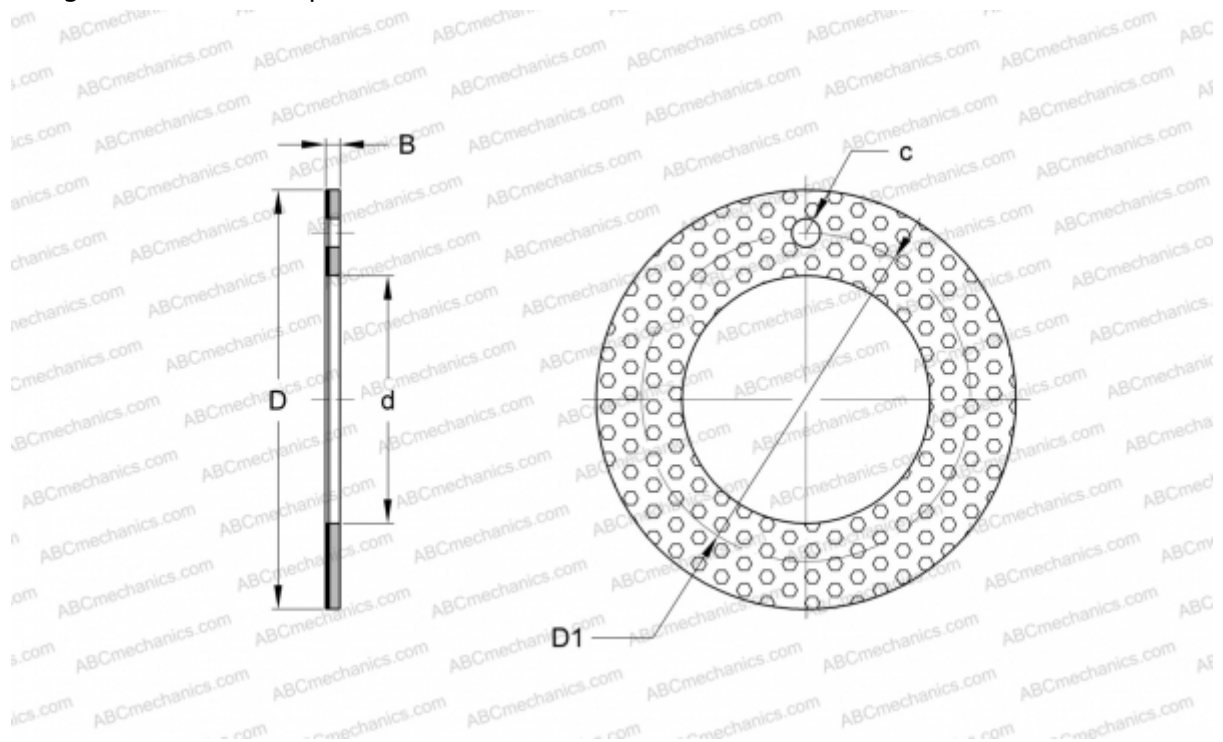

Technical specification

DIMENSIONS, MM

d	14,000
D	26,000
D1	20,000
B	1,500
c	2,000

WEIGHT, KG 0,003

MANUFACTURER [INA](#)

REPLACES

PAW14-P20