

EGW26-E50 INA

Thrust washers

TYPE: Plain bearings, Bushings, thrust washers and strips, Thrust washers, Low-maintenance, with steel backing and lubrication pockets (INA)

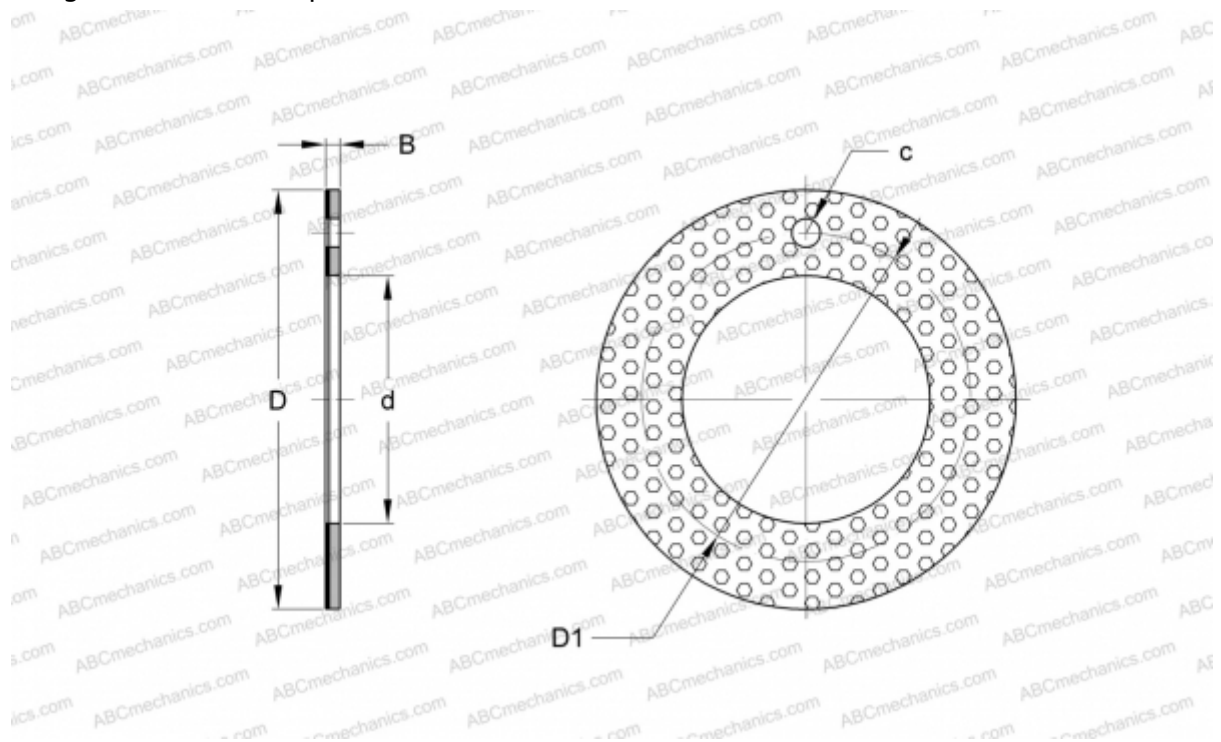

Technical specification

DIMENSIONS, MM

d	26,000
D	44,000
D1	35,000
B	1,500
c	3,000

WEIGHT, KG 0,008

MANUFACTURER [INA](#)

REPLACES

PAW26-P20