

EGW32-E50 INA

Thrust washers

TYPE: Plain bearings, Bushings, thrust washers and strips, Thrust washers, Low-maintenance, with steel backing and lubrication pockets (INA)

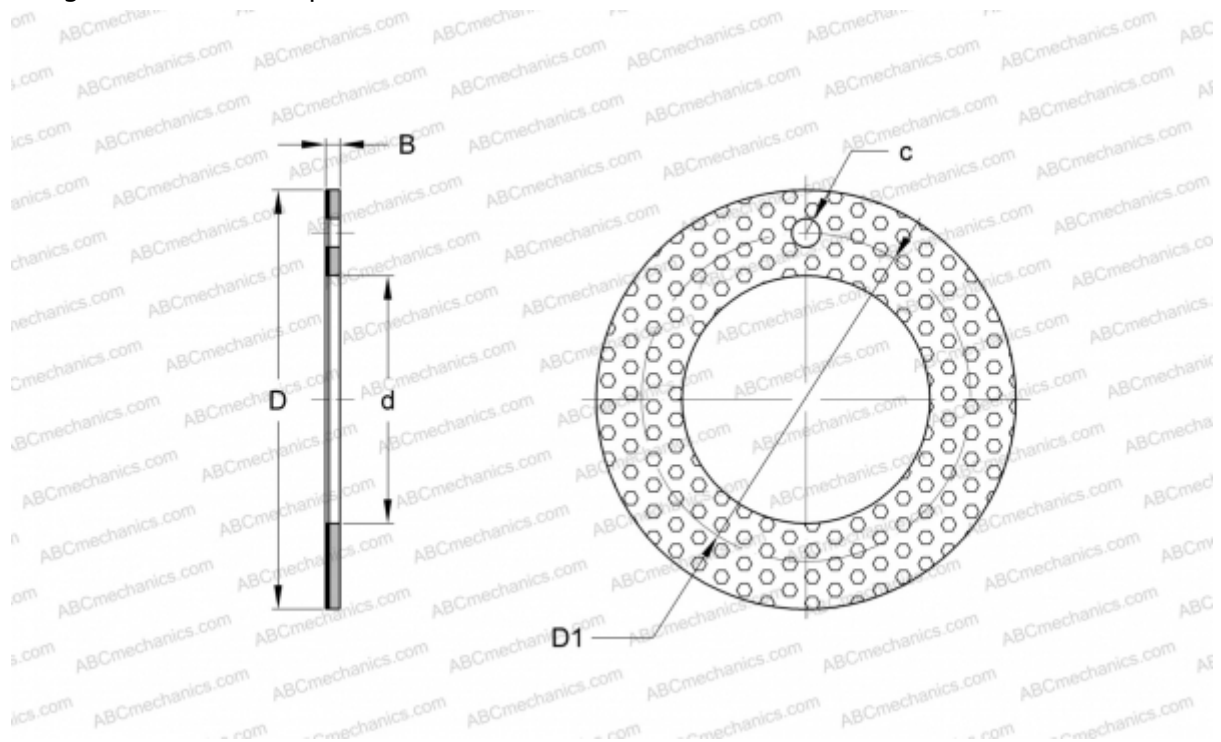

Technical specification

DIMENSIONS, MM

d	32,000
D	54,000
D1	43,000
B	1,500
c	4,000

WEIGHT, KG 0,012

MANUFACTURER [INA](#)

REPLACES

PAW32-P20