

## EGW42-E50 INA

Thrust washers

TYPE: Plain bearings, Bushings, thrust washers and strips, Thrust washers, Low-maintenance, with steel backing and lubrication pockets (INA)

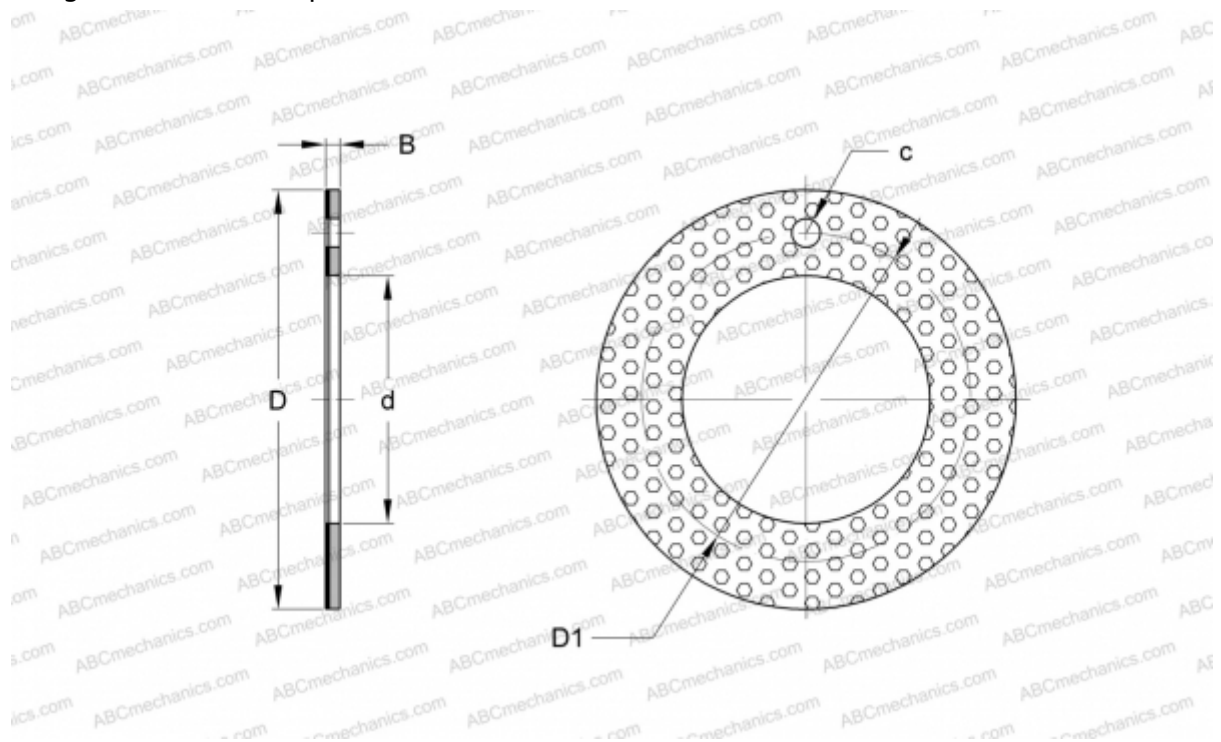

### Technical specification

#### DIMENSIONS, MM

d	42,000
D	66,000
D1	54,000
B	1,500
c	4,000

**WEIGHT, KG** 0,017

**MANUFACTURER** [INA](#)

#### REPLACES

PAW42-P20