

PCMW 325401.5 M SKF

Thrust washers

TYPE: Plain bearings, Bushings, thrust washers and strips, Thrust washers, Maintenance-free, POM composite (SKF)

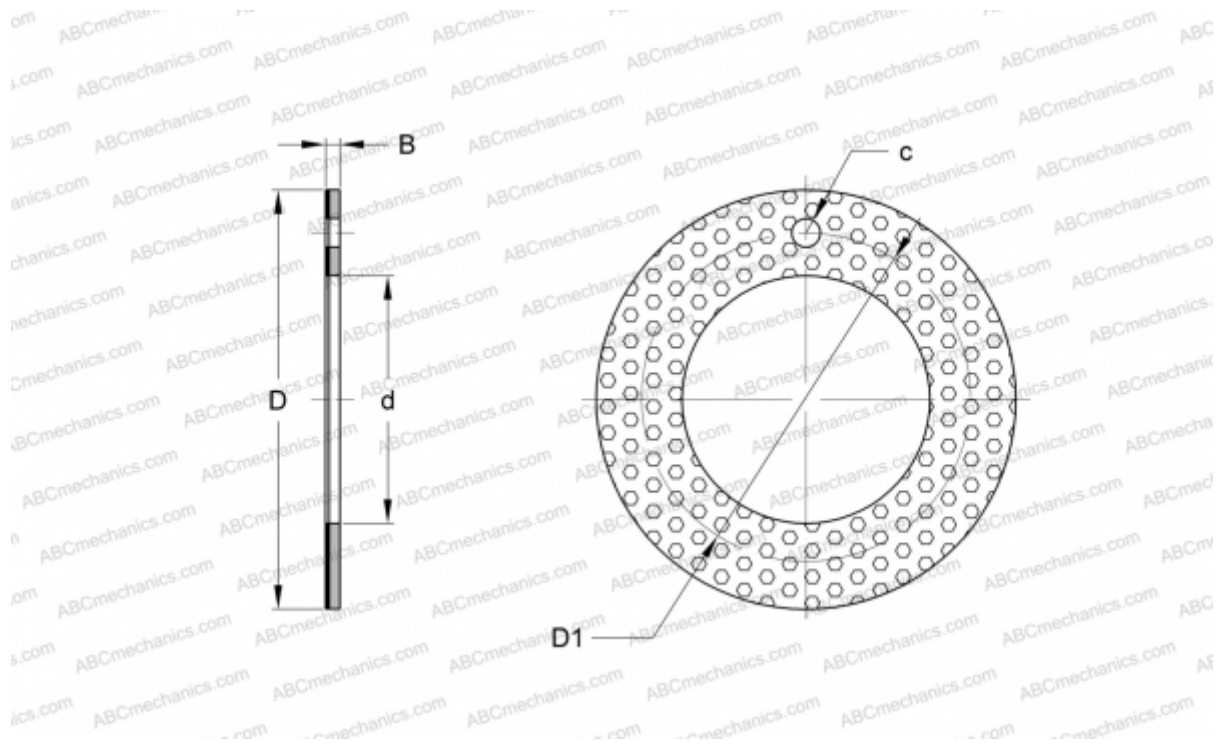

Technical specification

DIMENSIONS, MM

d	32,000
D	54,000
D1	43,000
B	1,500
c	4,250

WEIGHT, KG 0,014

MANUFACTURER [SKF](#)