

IR-061012 NSK

Inner ring

TYPE: Rolling bearing parts and accessories, Inner ring, For solid needle roller bearings, type IR (NSK), inch size

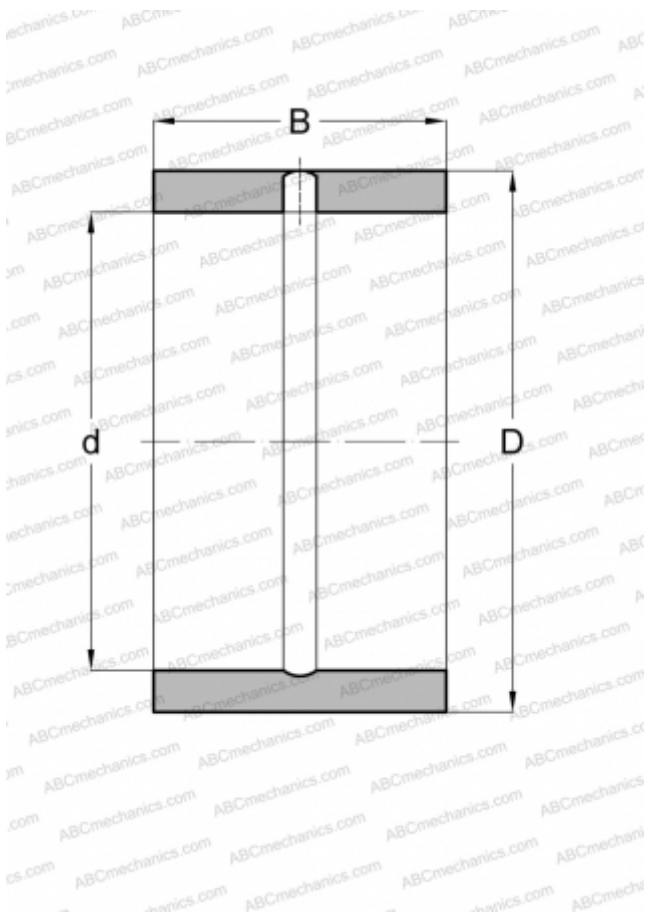

Technical specification

DIMENSIONS, MM

d	9,525
D	15,875
B	19,050

WEIGHT, KG

0,018

MANUFACTURER

[NSK](#)

ASSOCIATED PRODUCTS

HJ-101812