

IR-081216 NSK

Inner ring

TYPE: Rolling bearing parts and accessories, Inner ring, For solid needle roller bearings, type IR (NSK), inch size

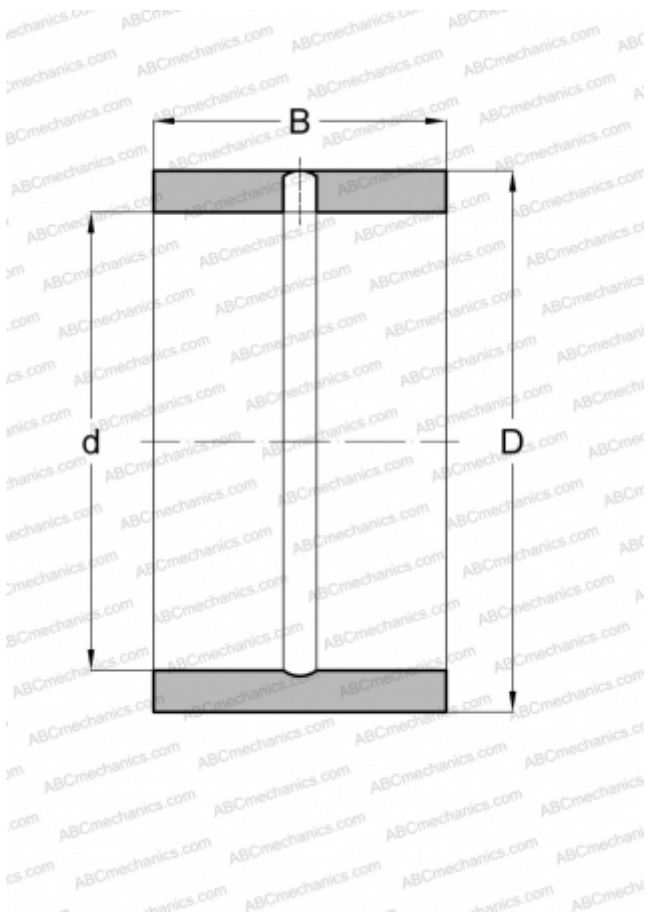

Technical specification

DIMENSIONS, MM

d	12,700
D	19,050
B	25,400

WEIGHT, KG

0,037

MANUFACTURER

[NSK](#)

ASSOCIATED PRODUCTS

HJ-122016