

## IR-121612 NSK

Inner ring

TYPE: Rolling bearing parts and accessories, Inner ring, For solid needle roller bearings, type IR (NSK), inch size

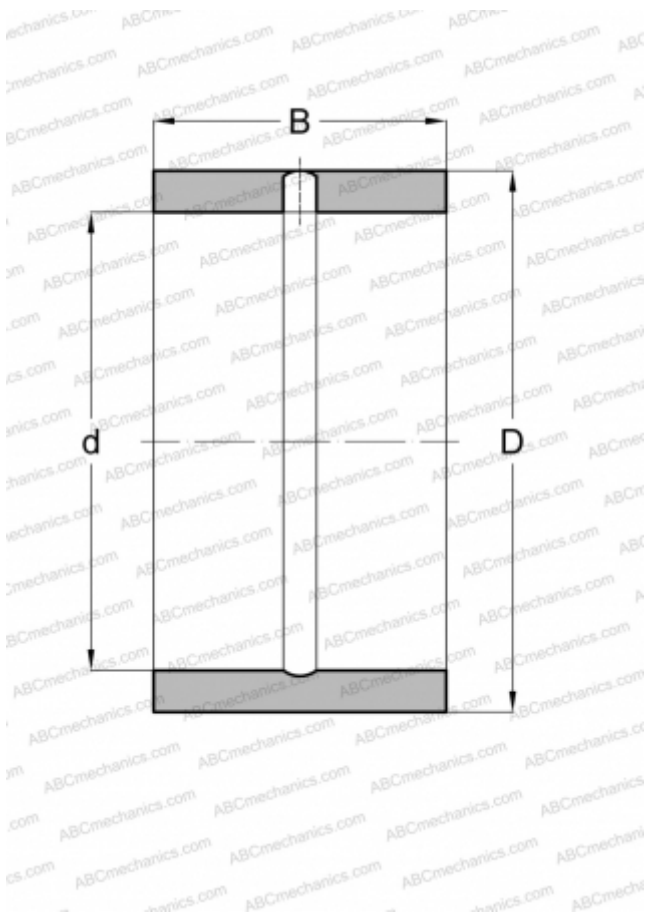

### Technical specification

#### DIMENSIONS, MM

d	19,050
D	25,400
B	19,050

#### WEIGHT, KG

0,032

#### MANUFACTURER

[NSK](#)

#### ASSOCIATED PRODUCTS

HJ-162412