

IR-131616 NSK

Inner ring

TYPE: Rolling bearing parts and accessories, Inner ring, For solid needle roller bearings, type IR (NSK), inch size

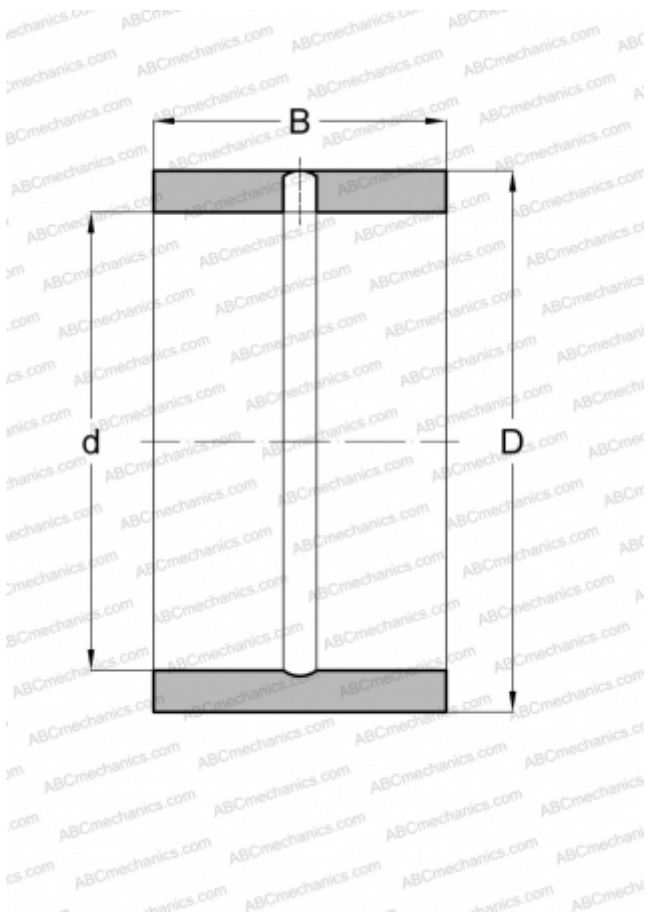

Technical specification

DIMENSIONS, MM

d	20,638
D	25,400
B	25,400

WEIGHT, KG

0,034

MANUFACTURER

[NSK](#)

ASSOCIATED PRODUCTS

HJ-162416