

## IR-162016 NSK

Inner ring

TYPE: Rolling bearing parts and accessories, Inner ring, For solid needle roller bearings, type IR (NSK), inch size

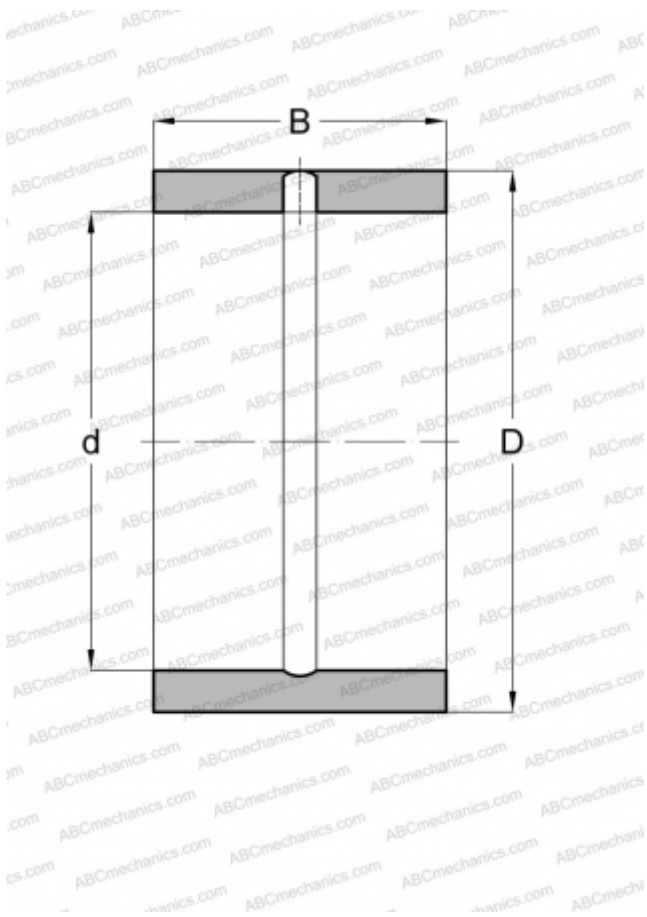

### Technical specification

#### DIMENSIONS, MM

d	25,400
D	31,750
B	25,400

#### WEIGHT, KG

0,060

#### MANUFACTURER

[NSK](#)

#### ASSOCIATED PRODUCTS

HJ-202816