

IR-162020 NSK

Inner ring

TYPE: Rolling bearing parts and accessories, Inner ring, For solid needle roller bearings, type IR (NSK), inch size

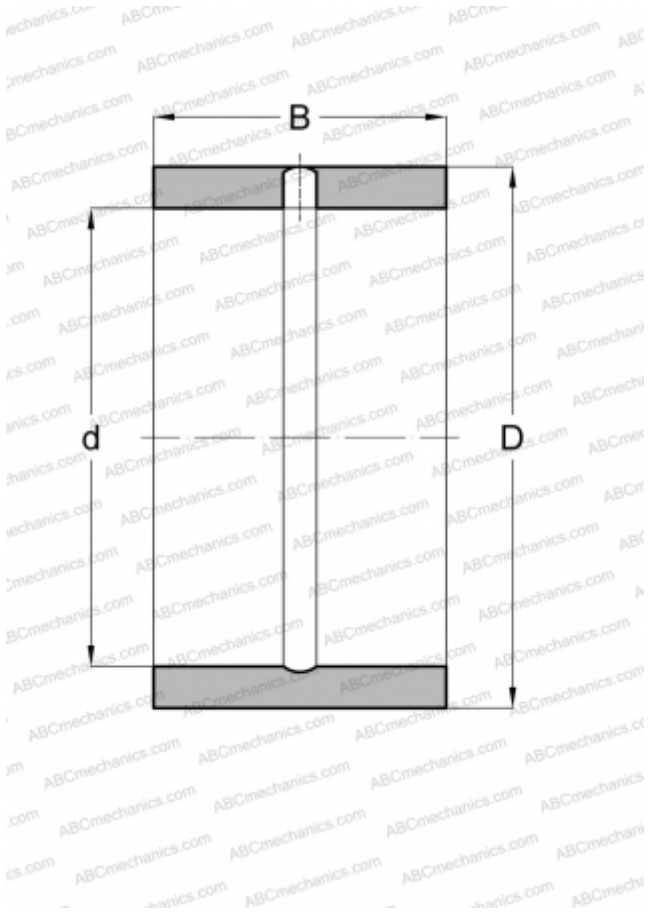

Technical specification

DIMENSIONS, MM

d	25,400
D	31,750
B	31,750

WEIGHT, KG

0,075

MANUFACTURER

[NSK](#)

ASSOCIATED PRODUCTS

HJ-202820