

## IR-182216 NSK

Inner ring

TYPE: Rolling bearing parts and accessories, Inner ring, For solid needle roller bearings, type IR (NSK), inch size

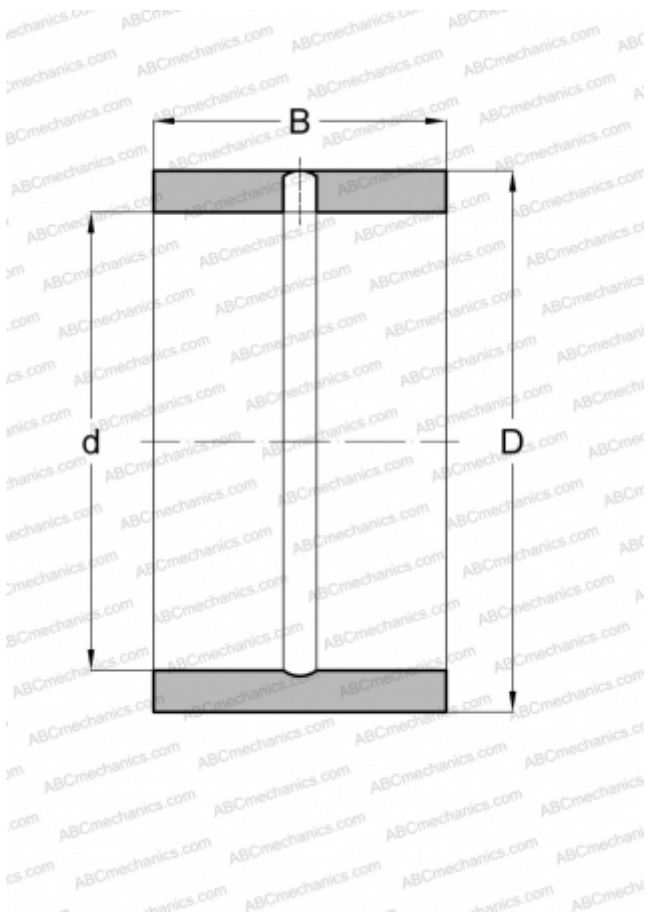

### Technical specification

#### DIMENSIONS, MM

d	28,575
D	34,925
B	25,400

#### WEIGHT, KG

0,065

#### MANUFACTURER

[NSK](#)

#### ASSOCIATED PRODUCTS

HJ-223016