

IR-212620 NSK

Inner ring

TYPE: Rolling bearing parts and accessories, Inner ring, For solid needle roller bearings, type IR (NSK), inch size

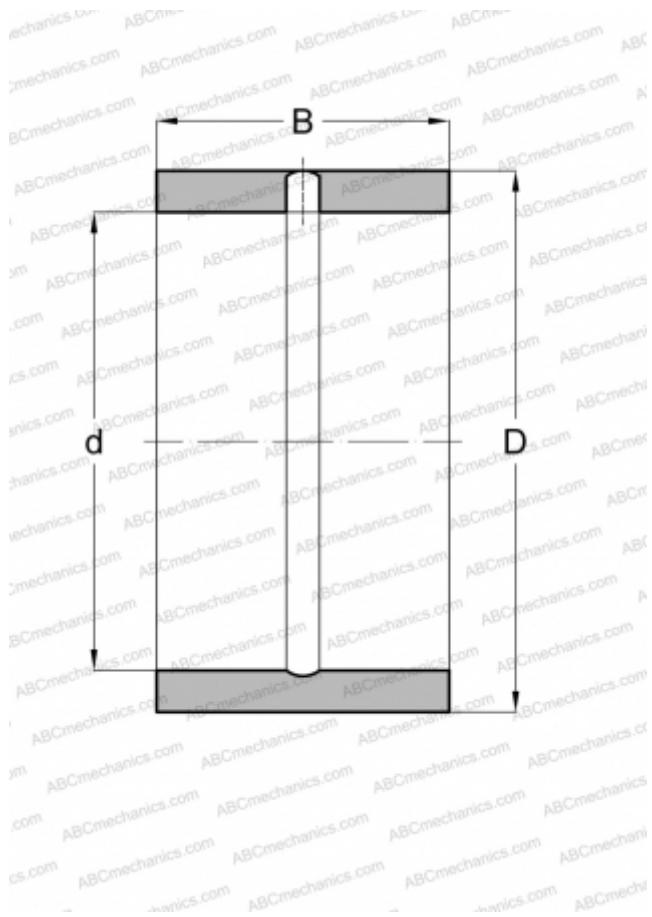

Technical specification

DIMENSIONS, MM

d	33,338
D	41,275
B	31,750

WEIGHT, KG

0,120

MANUFACTURER

[NSK](#)

ASSOCIATED PRODUCTS

HJ-263520