

IR-253220 NSK

Inner ring

TYPE: Rolling bearing parts and accessories, Inner ring, For solid needle roller bearings, type IR (NSK), inch size

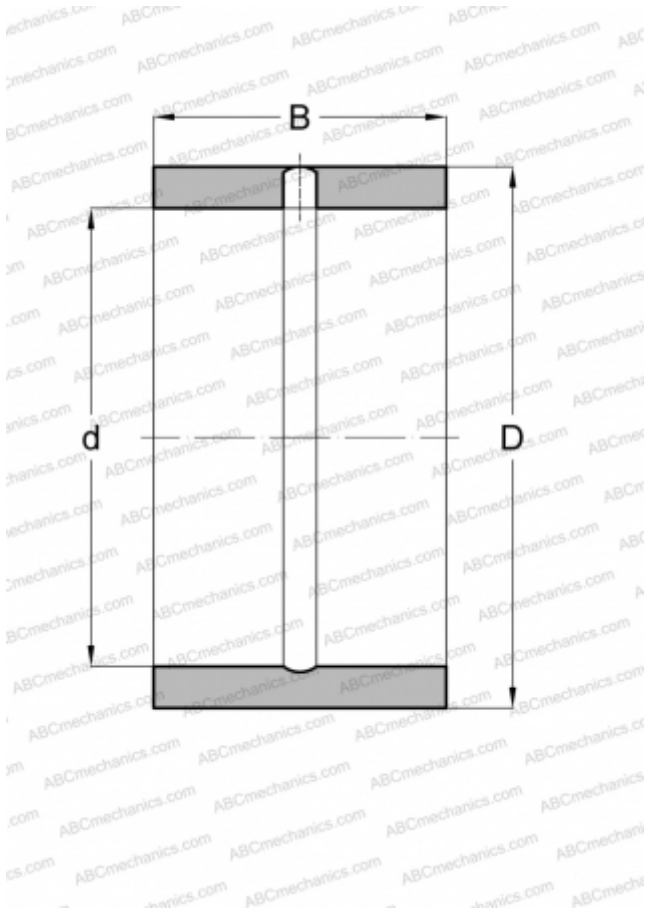

Technical specification

DIMENSIONS, MM

d	39,688
D	50,800
B	31,750

WEIGHT, KG

0,195

MANUFACTURER

[NSK](#)

ASSOCIATED PRODUCTS

HJ-324120