

## IR-314024 NSK

Inner ring

TYPE: Rolling bearing parts and accessories, Inner ring, For solid needle roller bearings, type IR (NSK), inch size

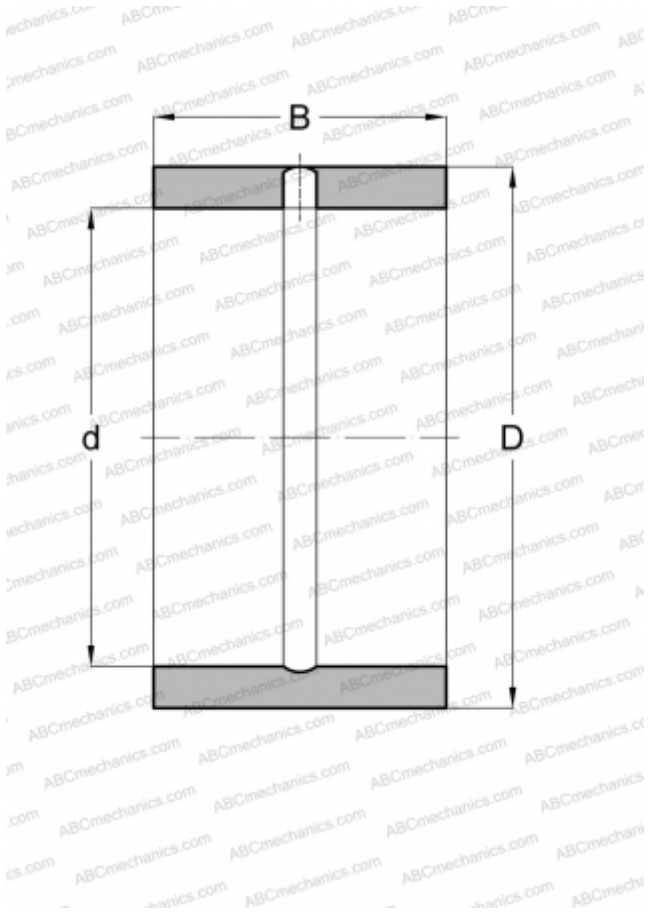

### Technical specification

#### DIMENSIONS, MM

d	49,212
D	63,500
B	38,100

#### WEIGHT, KG

0,375

#### MANUFACTURER

[NSK](#)

#### ASSOCIATED PRODUCTS

HJ-405224