

IR-324024 NSK

Inner ring

TYPE: Rolling bearing parts and accessories, Inner ring, For solid needle roller bearings, type IR (NSK), inch size

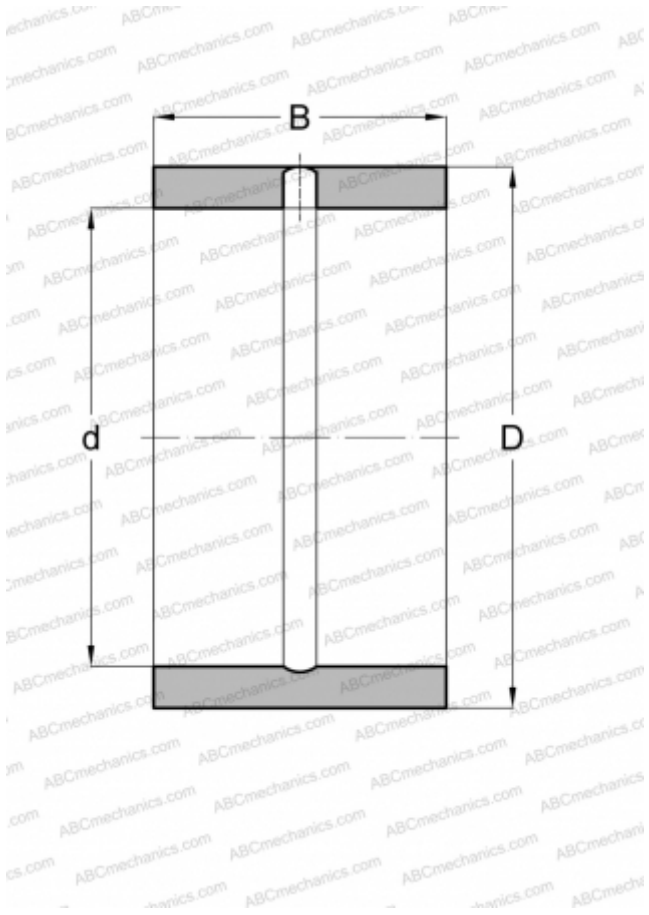

Technical specification

DIMENSIONS, MM

d	50,800
D	63,500
B	38,100

WEIGHT, KG

0,340

MANUFACTURER

[NSK](#)

ASSOCIATED PRODUCTS

HJ-405224