

IR-354428 NSK

Inner ring

TYPE: Rolling bearing parts and accessories, Inner ring, For solid needle roller bearings, type IR (NSK), inch size

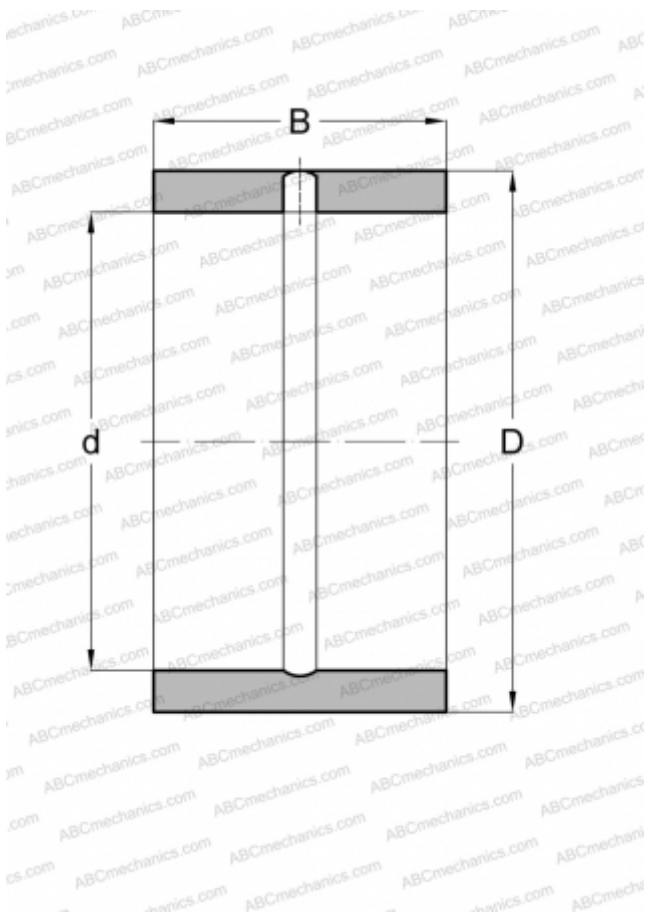

Technical specification

DIMENSIONS, MM

d	55,562
D	69,850
B	44,450

WEIGHT, KG

0,500

MANUFACTURER

[NSK](#)

ASSOCIATED PRODUCTS

HJ-445628