

IR-364424 NSK

Inner ring

TYPE: Rolling bearing parts and accessories, Inner ring, For solid needle roller bearings, type IR (NSK), inch size

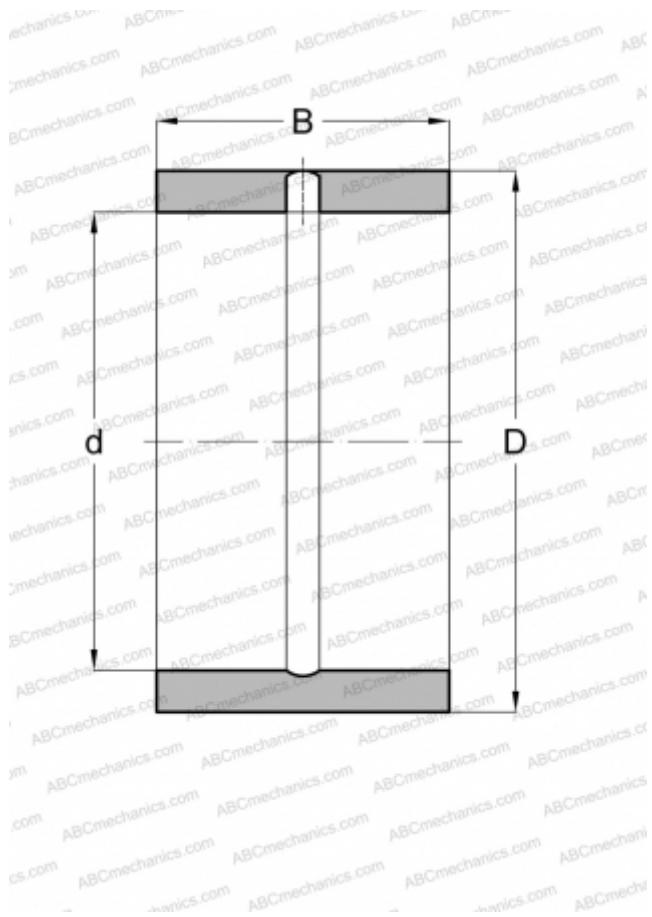

Technical specification

DIMENSIONS, MM

d	57,150
D	69,850
B	38,100

WEIGHT, KG

0,375

MANUFACTURER

[NSK](#)

ASSOCIATED PRODUCTS

HJ-445624