

## IR-384828 NSK

Inner ring

TYPE: Rolling bearing parts and accessories, Inner ring, For solid needle roller bearings, type IR (NSK), inch size

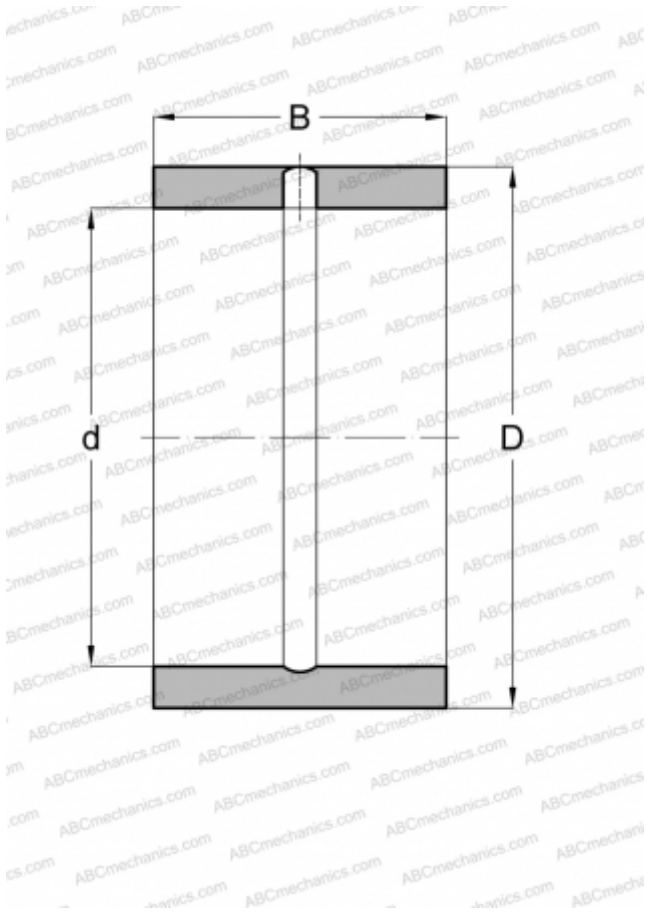

### Technical specification

#### DIMENSIONS, MM

d	60,325
D	76,200
B	44,450

#### WEIGHT, KG

0,570

#### MANUFACTURER

[NSK](#)

#### ASSOCIATED PRODUCTS

HJ-486028