

IR-445232 NSK

Inner ring

TYPE: Rolling bearing parts and accessories, Inner ring, For solid needle roller bearings, type IR (NSK), inch size

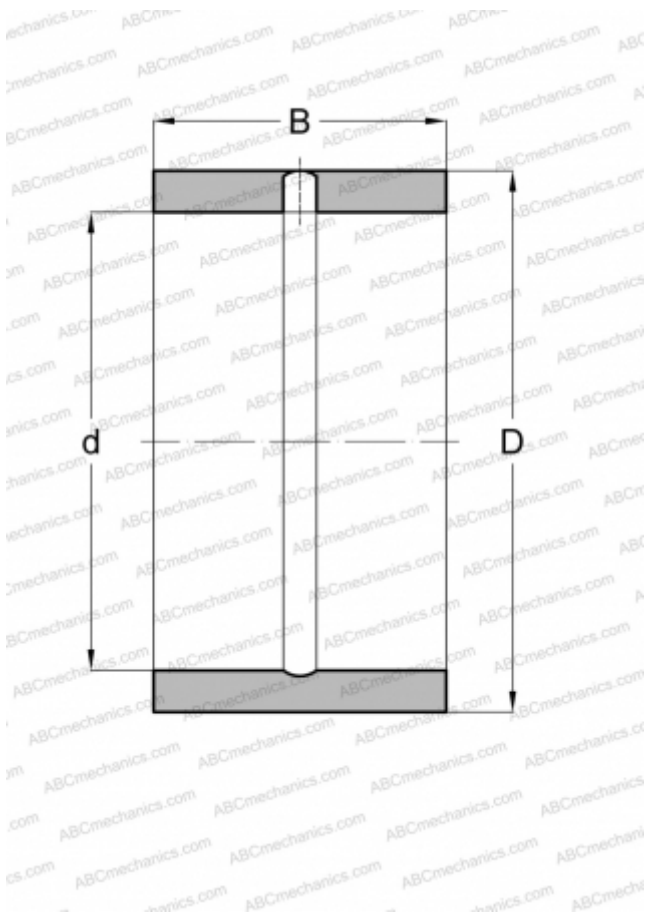

Technical specification

DIMENSIONS, MM

d	69,850
D	82,550
B	50,800

WEIGHT, KG

0,600

MANUFACTURER

[NSK](#)

ASSOCIATED PRODUCTS

HJ-526832