

IR-485632 NSK

Inner ring

TYPE: Rolling bearing parts and accessories, Inner ring, For solid needle roller bearings, type IR (NSK), inch size

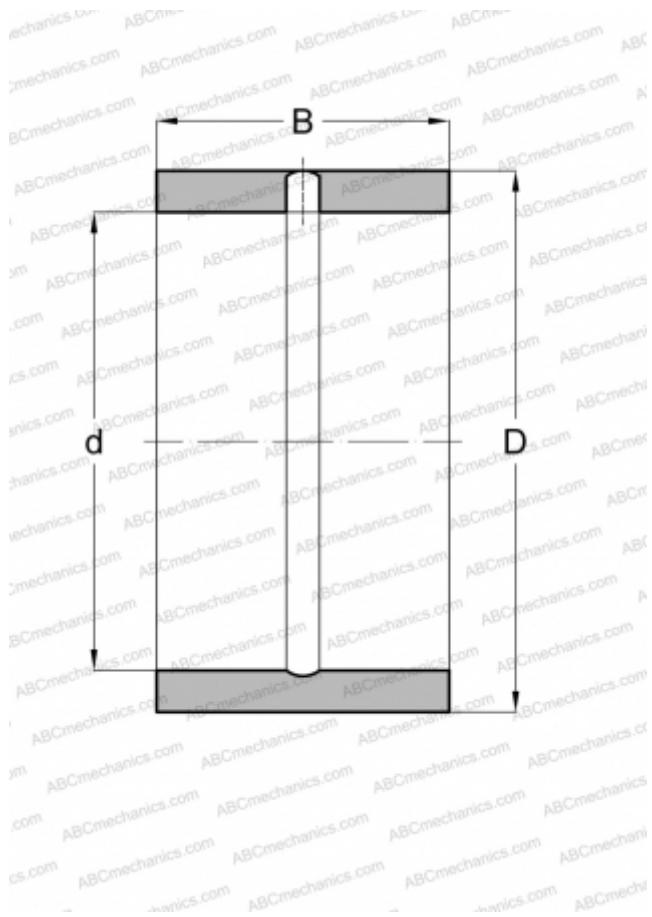

Technical specification

DIMENSIONS, MM

d	76,200
D	88,900
B	50,800

WEIGHT, KG

0,700

MANUFACTURER

[NSK](#)

ASSOCIATED PRODUCTS

HJ-567232