

IR-688036 NSK

Inner ring

TYPE: Rolling bearing parts and accessories, Inner ring, For solid needle roller bearings, type IR (NSK), inch size

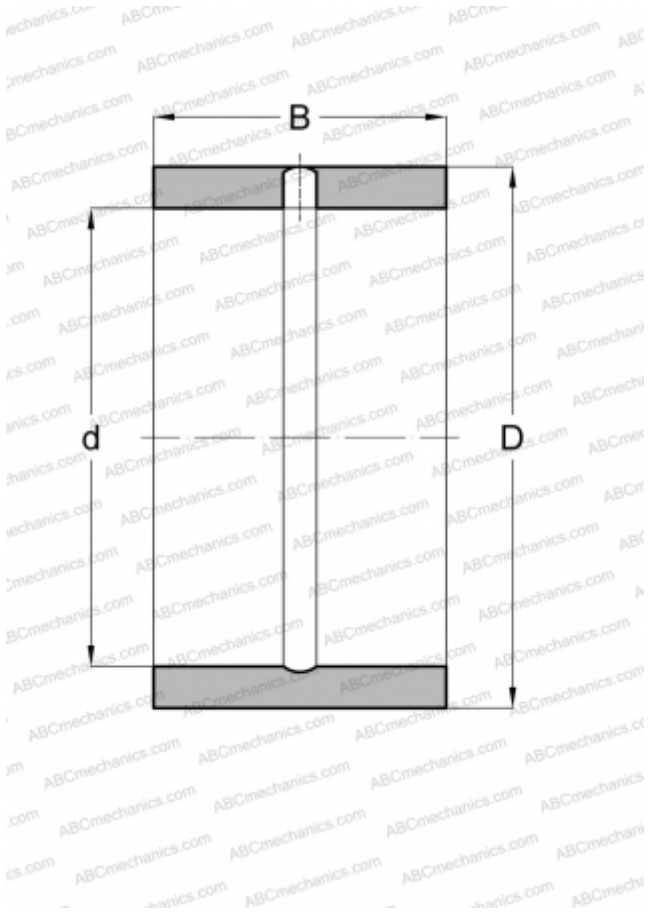

Technical specification

DIMENSIONS, MM

d	107,950
D	127,000
B	57,150

WEIGHT, KG

1,550

MANUFACTURER

[NSK](#)

ASSOCIATED PRODUCTS

HJ-8010436