

IR-728840 NSK

Inner ring

TYPE: Rolling bearing parts and accessories, Inner ring, For solid needle roller bearings, type IR (NSK), inch size

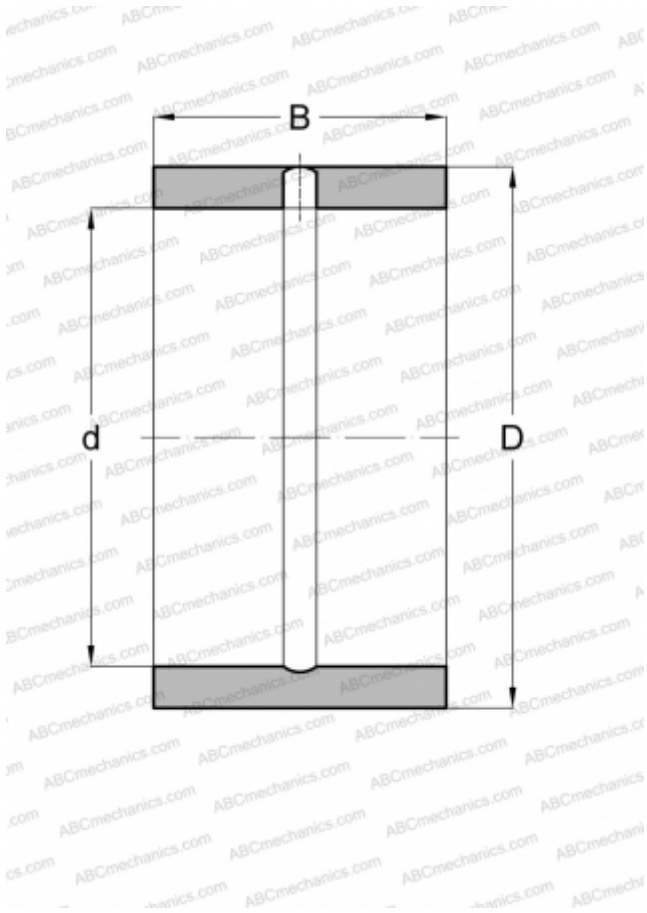

Technical specification

DIMENSIONS, MM

d	114,300
D	139,700
B	63,500

WEIGHT, KG

2,500

MANUFACTURER

[NSK](#)

ASSOCIATED PRODUCTS

HJ-8811240