

IR-10412448 NSK

Inner ring

TYPE: Rolling bearing parts and accessories, Inner ring, For solid needle roller bearings, type IR (NSK), inch size

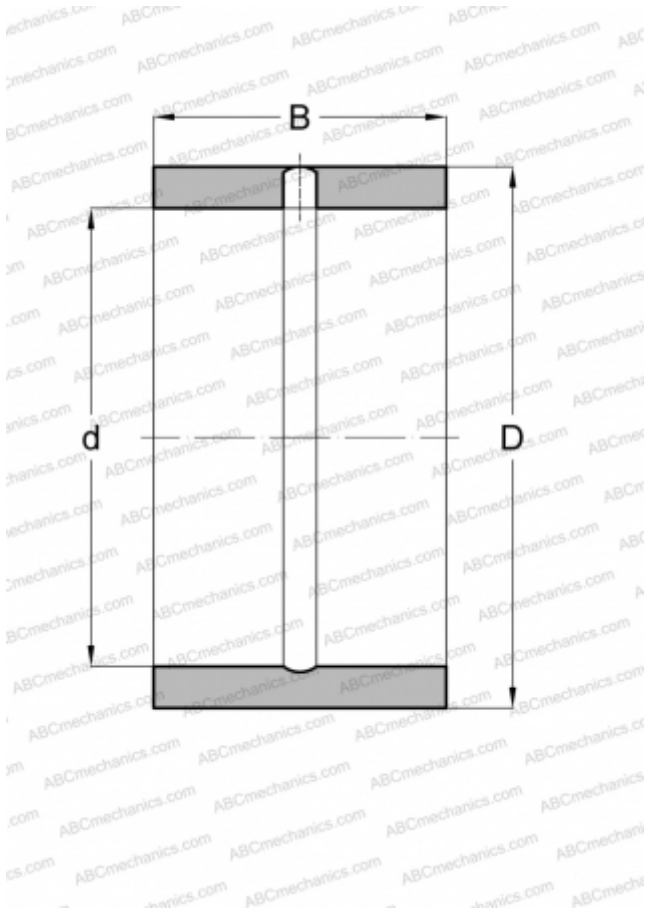

Technical specification

DIMENSIONS, MM

d	165,100
D	196,850
B	76,200

WEIGHT, KG

5,500

MANUFACTURER

[NSK](#)

ASSOCIATED PRODUCTS

HJ-12415448