

PCMW 264401.5 E SKF

Thrust washers

TYPE: Plain bearings, Bushings, thrust washers and strips, Thrust washers, Maintenance-free, PTFE composite (SKF)

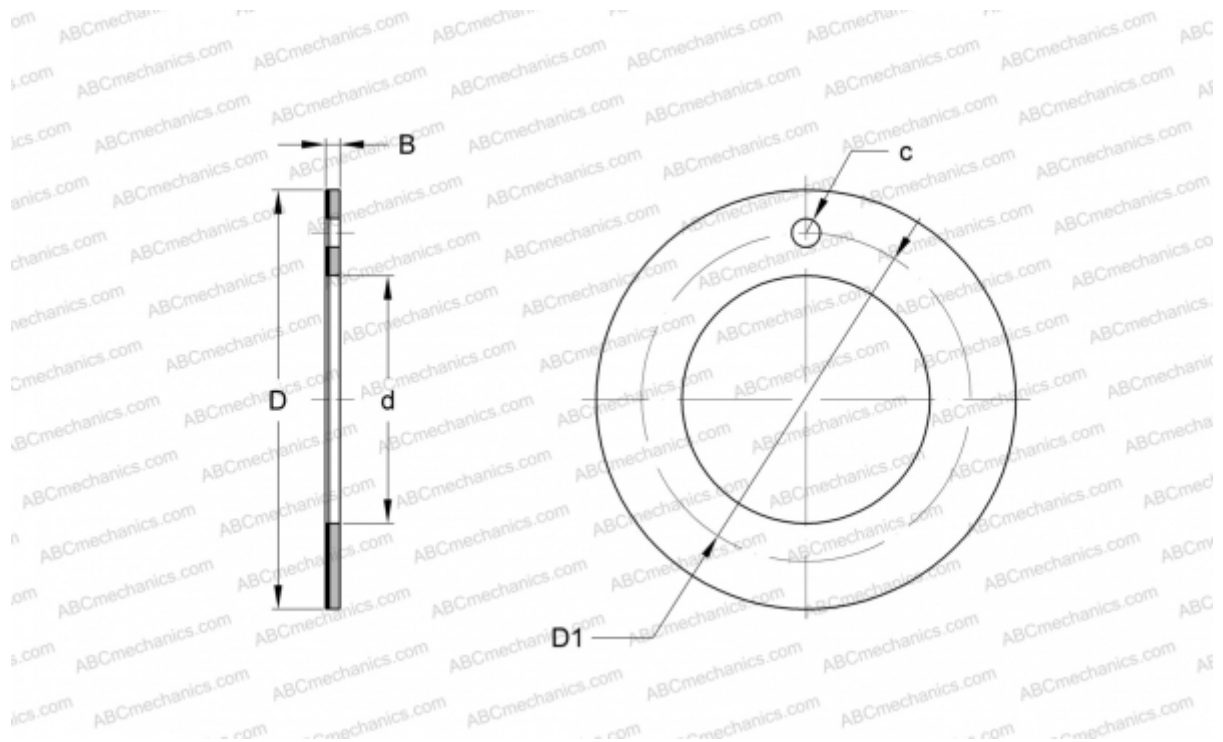

Technical specification

DIMENSIONS, MM

d	26,000
D	44,000
D1	35,000
B	1,500
c	3,250

WEIGHT, KG 0,011

MANUFACTURER [SKF](#)

REPLACES

PCMW264401.5B