

PCMW 284801.5 E SKF

Thrust washers

TYPE: Plain bearings, Bushings, thrust washers and strips, Thrust washers, Maintenance-free, PTFE composite (SKF)

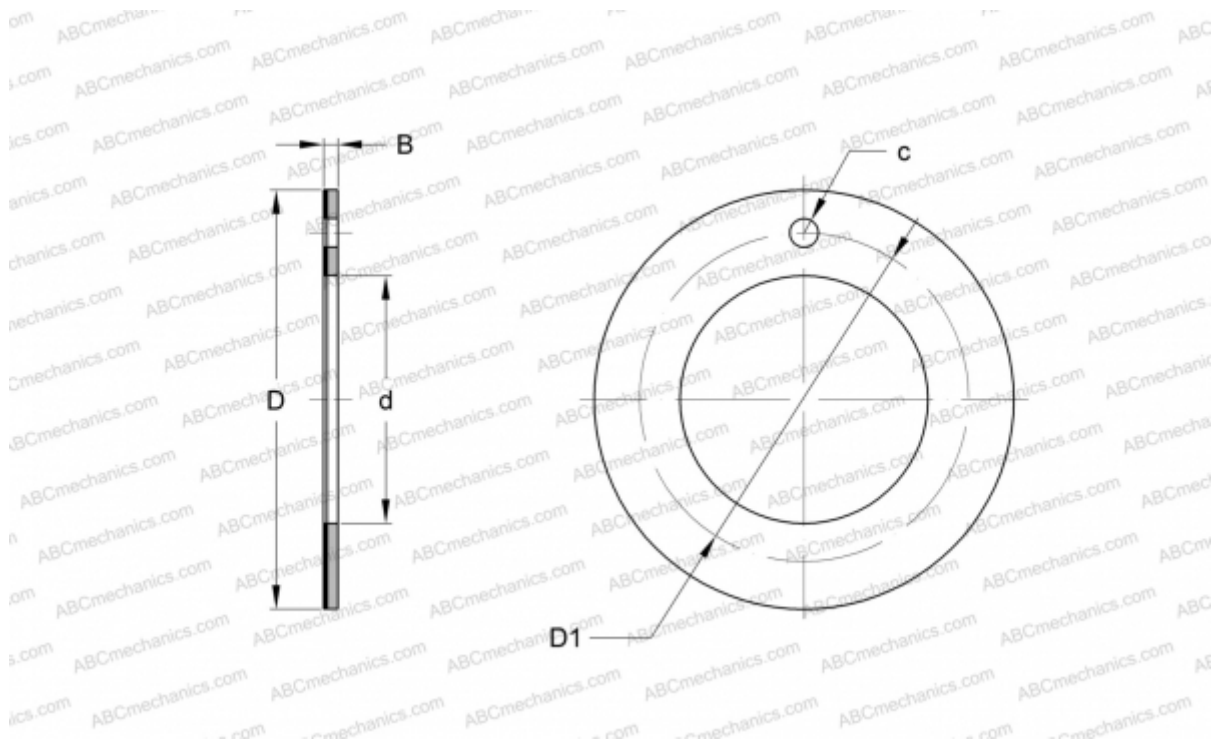

Technical specification

DIMENSIONS, MM

d	28,000
D	48,000
D1	38,000
B	1,500
c	4,250

WEIGHT, KG 0,013

MANUFACTURER [SKF](#)

REPLACES

PCMW284801.5B