

## PCMW 426601.5 E SKF

Thrust washers

TYPE: Plain bearings, Bushings, thrust washers and strips, Thrust washers, Maintenance-free, PTFE composite (SKF)

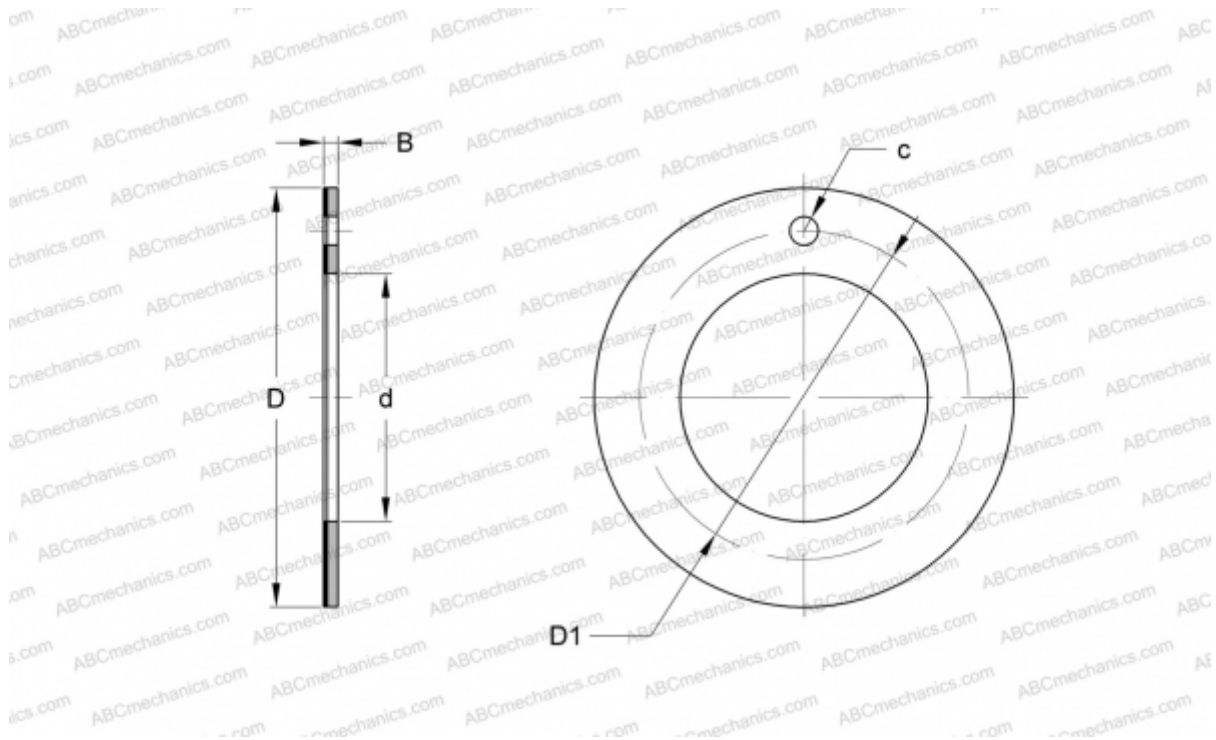

### Technical specification

#### DIMENSIONS, MM

d	42,000
D	66,000
D1	54,000
B	1,500
c	4,250

**WEIGHT, KG** 0,023

**MANUFACTURER** [SKF](#)

#### REPLACES

PCMW426601.5B