

311-SFG MRC

Deep groove ball bearings

TYPE: Ball bearings, Radial ball bearings, Single row, With snap ring groove, Snap ring, shield Z

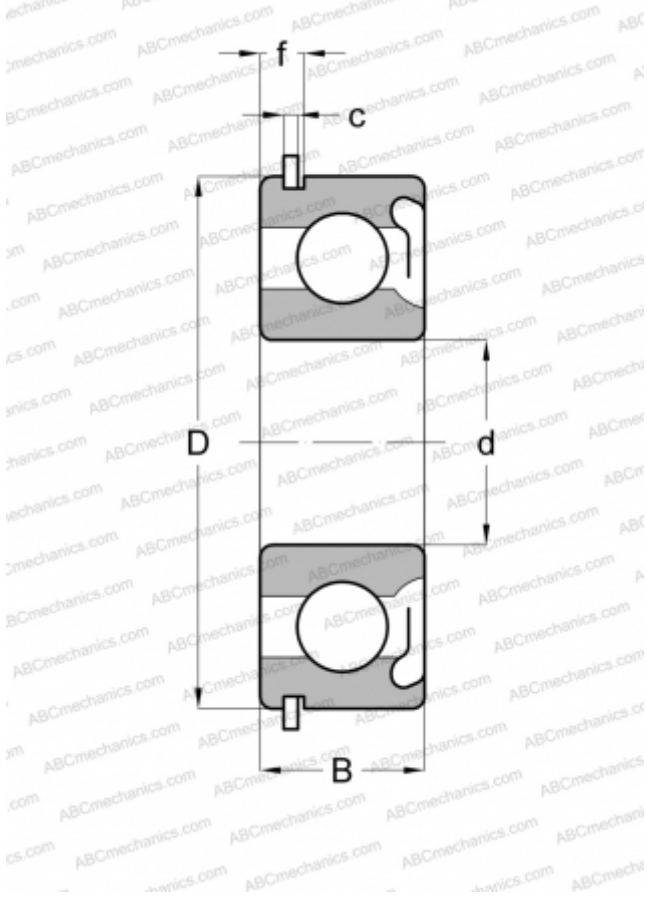

Technical specification

DIMENSIONS, MM

d	55,000
D	120,000
B	29,000
f	7,137
c	3,099

WEIGHT, KG

1,370

MANUFACTURER

[MRC](#)

INTERCHANGE

ABC	6311 ZNR
SKF	6311-ZNR
FAG	6311 ZNR
STEYR	6311 ZNR
NEW DEPARTURE	47611