

304-SFFG MRC

Deep groove ball bearings

TYPE: Ball bearings, Radial ball bearings, Single row, With snap ring groove, Snap ring, shields 2Z

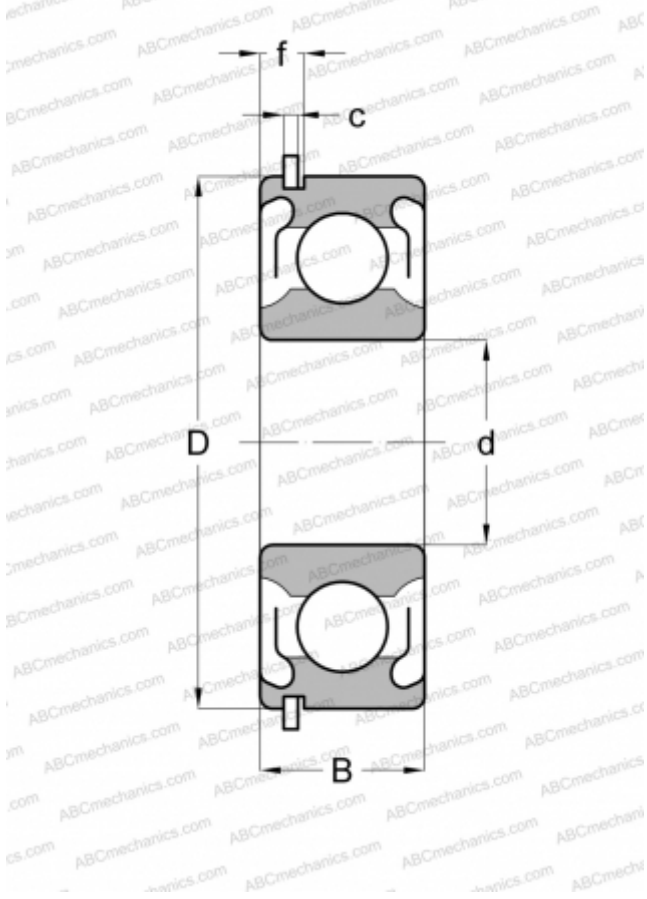

Technical specification

DIMENSIONS, MM

d	20,000
D	52,000
B	15,000
f	3,785
c	1,346

WEIGHT, KG

0,145

MANUFACTURER

[MRC](#)

INTERCHANGE

ABC	6304 2ZNR
SKF	6304-2ZNR
FAG	6304-2ZNR
FAFNIR	304KDDG
STEYR	6304-2ZNR
NEW DEPARTURE	477604