

6310-2ZNR SKF

Deep groove ball bearings

TYPE: Ball bearings, Radial ball bearings, Single row, With snap ring groove, Snap ring, shields 2Z

Technical specification

DIMENSIONS, MM

d	50,000
D	110,000
B	27,000
c	2,460

WEIGHT, KG

1,050

MANUFACTURER

[SKF](#)

INTERCHANGE

ABC	6310 2ZNR
MRC	310-SFFG
FAG	6310-2ZNR
FAFNIR	310KDDG
STEYR	6310-2ZNR
NEW DEPARTURE	477610

CALCULATION DATA

Basic dynamic load rating, C	65,000 kN
Basic static load rating, Co	38,000 kN
Fatigue load limit, Pu	1,600 kN
Reference speed	13000 r/min
Limiting speed	8500 r/min

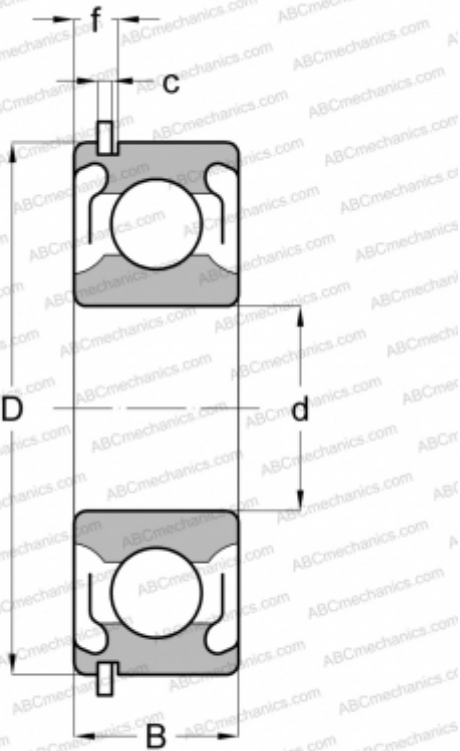

INCLUDED PRODUCTS

SP 110 Snap ring