

3309 A-2RS1 SKF

Angular contact ball bearings

TYPE: Ball bearings, Angular contact ball bearing, Double row, Contact angle 30°, Lip seals on both side

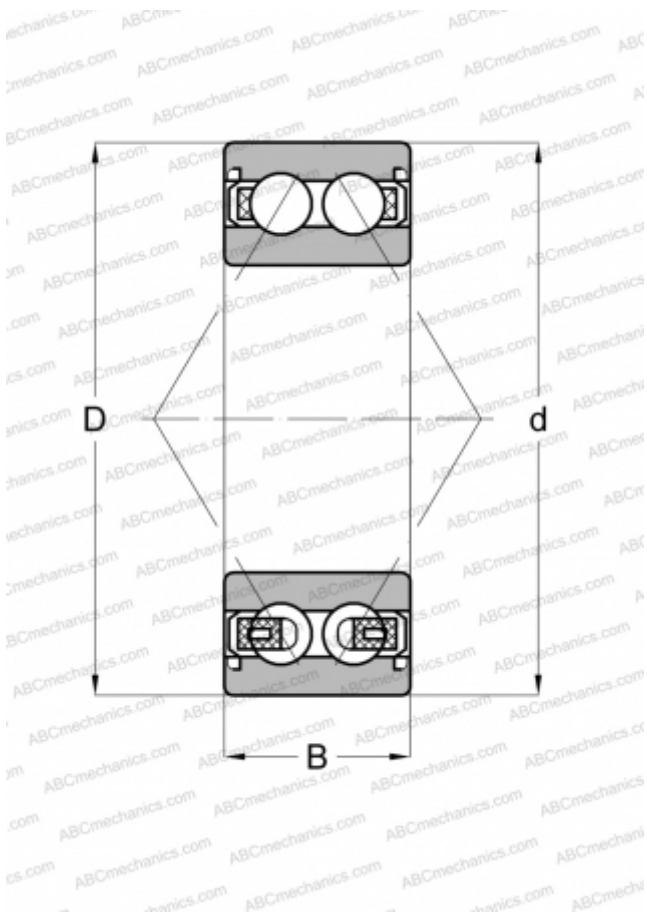

Technical specification

DIMENSIONS, MM

d	45,000
D	100,000
B	39,700

WEIGHT, KG

1,250

MANUFACTURER

[SKF](#)

INTERCHANGE

ABC	3309 BD 2RSR TVH
FAG	3309 BD 2RSR TVH

CALCULATION DATA

Basic dynamic load rating, C	75,000 kN
Basic static load rating, Co	53,000 kN
Fatigue load limit, Pu	2,240 kN
Reference speed	6700 r/min
Limiting speed	4800 r/min